

TECHNICAL MANUAL

**OPERATOR'S, ORGANIZATIONAL, DIRECT
SUPPORT AND GENERAL SUPPORT
MAINTENANCE MANUAL (INCLUDING
REPAIR PARTS AND SPECIAL TOOLS LIST)**

FOR

SIGNAL GENERATOR

AN/URM-206

(NSN 6625-01-077-8503) (EIC: KMF)

DISTRIBUTION STATEMENT A – Approved for public release; distribution is unlimited.

**HEADQUARTERS, DEPARTMENT OF THE ARMY
28 DECEMBER 1979**

WARNINGS

The stabilizer input terminal board, on the rear panel, has a regulated potential of 1850 volts dc on its terminals. Severe shock or DEATH may result from accidental contact with these terminals. The terminals are covered to prevent accidental contact. The cover should not be removed unless an external lock box is to be connected.

A regulated dc voltage of 1850 volts will be encountered during the troubleshooting tests. Do not connect or disconnect test equipment which connects internally with the instrument energized.

Before attempting any disassembly or reassembly procedures make sure that the power switches on models SG-1145/URM and MD-1075/URM are in their off positions and the power cord has been disconnected from the power source.

CHANGE }
No. 2 }

Headquarters
Department of the Army
Washington, D.C., 06 July 2006

**OPERATOR'S, ORGANIZATIONAL, DIRECT SUPPORT AND GENERAL SUPPORT
MAINTENANCE MANUAL (INCLUDING REPAIR PARTS AND SPECIAL TOOLS LIST)
FOR
SIGNAL GENERATOR
AN/URM-206
(NSN 6625-01-077-8503) (EIC: KMF)**

DISTRIBUTION STATEMENT A – Approved for public release; distribution is unlimited.

TM 11-6625-2948-14&P dated 28 December 1979, is changed as follows:

1. Remove old pages and insert new pages as indicated below. New or changed material is indicated by a vertical bar in the outer margin of the page.

Remove Pages

A/(B Blank)
i through iii/(iv Blank)
1-1 and 1-2
4-1 through 4-4
A-1/(A-2 Blank)
D-3 and D-4
None
DA Forms 2028-2
Cover

Insert Pages

A/(B Blank)
i through iv
1-1 and 1-2
4-1 through 4-4
A-1/(A-2 Blank)
D-3 and D-4
F-1/(F-2 Blank)
DA Forms 2028
Cover

2. File this change sheet in front of the publication for reference purposes.

By Order of the Secretary of the Army:

Official:

JOYCE E. MORROW
*Administrative Assistant to the
Secretary of the Army*
06142

PETER J. SCHOOMAKER
*General, United States Army
Chief of Staff*

DISTRIBUTION:

To be distributed in accordance with the Initial Distribution Number (IDN) 363273,
requirements for TM 11-6625-2948-14&P.

Change

HEADQUARTERS
DEPARTMENT OF THE ARMY
Washington, DC, 18 October 1982

No.

Operator's, Organizational, Direct Support and General Support Maintenance Manual

SIGNAL GENERATOR AN/URM-206 (NSN 6625-01-077-8503)

TM 11-6625-2948-14&P, 28 December 1979, is changed as follows:

1. Title of manual is changed as shown above.
2. New or changed material is indicated by a vertical bar in the margin of the page.
3. Added or revised illustrations are indicated by a vertical bar in front of the figure caption.
4. Remove and insert pages as indicated below:

<i>Remove</i>	<i>Insert</i>
i and ii	i and ii
iii	iii/(iv blank)
1-1 and 1-2	1-1 and 1-2
2-5 and 2-6	2-5 and 2-6
3-1 through 3-8	3-1 through 3-8
4-9 through 4-12	4-9 through 4-12
4-17 through 4-18	4-17 through 4-18.2
4-19 through 4-22	4-19 through 4-22. 1/(422.2 blank)
4-29 through 4-33	4-29 through 4-33/(4-34 blank)
A - 1	A-1
None	5-4. 1/(5-4.2 blank)
None	5-6. 1/(5-6.2 blank)
6.1 through 6-18	None

5. File this change sheet in front of the publication for reference purposes.

By Order of the Secretary of the Army:

E. C. MEYER
General, United States Army
Chief of Staff

Official:

ROBERT M. JOYCE
Major General, United States Army
The Adjutant General

DISTRIBUTION:

To be distributed in accordance with Special List.

INSERT LATEST CHANGED PAGES. DESTROY SUPERSEDED PAGES.

LIST OF EFFECTIVE PAGES

NOTE

ON CHANGED PAGES, THE PORTION OF THE TEXT AFFECTED BY THE LATEST CHANGE IS INDICATED BY A VERTICAL LINE OR OTHER CHANGE SYMBOL IN THE OUTER MARGIN OF THE PAGE.

Date of issue for original and changed pages are:

Original	0	28 December 1979
Change	1	18 October 1982
Change	2	06 July 2006

Total number of pages in this publication is 110 consisting of the following:

Page No.	* Change No.	Page No.	*Change No.
Cover	2	5-3	0
A	2	5-4 Blank	0
B Blank	2	5-4.1	1
i through iv	2	5-4.2 Blank	1
1-1	2	5-5	0
1-2	0	5-6 Blank	0
1-3 through 1-6	0	5-6.1	1
2-1 through 2-5	0	5-6.2 Blank	1
2-6	1	5-7	0
2-7 through 2-9	0	5-8 Blank	0
2-10 Blank	0	5-9	0
3-1	1	5-10 Blank	0
3-2 and 3-3	0	5-11	0
3-4	1	5-12 Blank	0
3-5	0	5-13	0
3-6 and 3-7	1	5-14 Blank	0
3-8 through 3-10	0	5-15 and 5-16	0
4-1 through 4-3	2	A-1	2
4-4 through 4-9	0	A-2 Blank	2
4-10 and 4-11	1	B-1 and B-2	0
4-12 through 4-16	0	C-1	0
4-17 through 4-22.1	1	C-2 Blank	0
4-22.2 Blank	1	D-1 and D-2	0
4-23 through 4-28	0	D-3 and D-4	2
4-29 through 4-33	1	E-1	0
4-34 Blank	1	E-2 Blank	0
5-1	0	F-1	2
5-2 Blank	0	F-2 Blank	2

*Zero in this column indicates an original page.

TECHNICAL MANUAL }
 No. 11-6625-2948-14&P }

HEADQUARTERS
 Department of the Army
 Washington, D.C., 28 December 1979

**OPERATOR'S, ORGANIZATIONAL, DIRECT SUPPORT
 AND GENERAL SUPPORT MAINTENANCE MANUAL
 (INCLUDING REPAIR PARTS AND SPECIAL TOOLS LIST)**

FOR

**GENERATOR, SIGNAL
 AN/URM-206**

(NSN 6625-01-077-8503) (EIC: KMF)

REPORTING ERRORS AND RECOMMENDING IMPROVEMENTS

You can help improve this manual. If you find any mistakes or if you know of a way to improve the procedures, please let us know. Mail your letter or DA Form 2028 (Recommended Changes to Publications and Blank Forms) directly to: Commander, U. S. Army Aviation and Missile Command, AMSAM-MMC-MA-NP, Redstone Arsenal, AL 35898-5000. A reply will be furnished to you. You may also provide DA Form 2028 information to AMCOM via email, fax or the World Wide Web. Our fax number is: DSN 788-6546 or Commercial 256-842-6546. Our email address is: 2028@redstone.army.mil. Instructions for sending an electronic 2028 may be found at the back of this manual immediately preceding the hardcopy 2028. For the World Wide Web use: <https://amcom2028.redstone.army.mil>.

DISTRIBUTION STATEMENT A – Approved for public release; distribution is unlimited.

TABLE OF CONTENTS

	Paragraph	Page
CHAPTER 1 INTRODUCTION.....		1-1
Section I. General.....		1-1
Scope	1-1	1-1
Consolidated Index of Army Publications and Blank Forms	1-2	1-1
Maintenance Forms, Records and Reports	1-3	1-1
Reporting Equipment Improvement Recommendations (EIRs)	1-4	1-1
Administrative Storage	1-5	1-1
Destruction of Army Material.....	1-6	1-1
Section II. Description and Data.....		1-3
Purpose and Use.....	1-7	1-3
Description of Equipment	1-8	1-3
Items Comprising an Operable Equipment	1-9	1-3
Technical Characteristics	1-10	1-3

	Paragraph	Page
CHAPTER 2	INSTALLATION AND OPERATION.....	2-1
	General.....	2-1
	Installation	2-2
	Operating Controls, Indicators and Connectors.....	2-3
	Operation.....	2-4
	CW Operation.....	2-5
	Internal Square Wave Modulation Operation.....	2-6
	Internal Pulse Modulation Operation.....	2-7
	External Pulse Modulation Operation.....	2-8
	Internal FM Operation (Internal to SG-1145/URM)	2-9
	Internal FM Operation (AN/URM-206)	2-10
	External FM Operation	2-11
	External Synchronization.....	2-12
	Packaging Instructions	2-13
CHAPTER 3	FUNCTIONING OF EQUIPMENT	3-1
	General.....	3-1
	Signal Generator SG-1145/URM	3-2
	Block Diagram Analysis, Signal Generator SG-1145/URM	3-3
	Signal Generator SG-1145/URM Circuit Analysis.....	3-4
	Klystron Oscillator	3-5
	Mode Switching	3-6
	Repeller Voltage Tracking System.....	3-7
	Protective Diode	3-8
	Frequency Control Knob	3-9
	Calibrated Attenuation Operation	3-10
	Schmitt Trigger and Amplifier.....	3-11
	Time Delay Circuit.....	3-12
	Square Wave Generator	3-13
	Modulation Selection.....	3-14
	ΔF Control	3-15
	Beam (-1250V), Repeller (-1850V) and the +40V (-128V) Ref Ground Power Supplies	3-16
	Klystron Filament Supply.....	3-17
	Power Supply Adjustments	3-18
	400 To 60 Hz Converter 1A10	3-19
	Modulator MD-1075/URM	3-20
	Block Diagram Analysis MD-1075/URM	3-21
	Modulator MD-1075/URM Circuit Analysis.....	3-22
CHAPTER 4	MAINTENANCE	4-1
	General.....	4-1
	Test Equipment Required.....	4-2
	Preventive Maintenance.....	4-3
	Minimum Performance Tests	4-4
	Troubleshooting.....	4-5
	Removal and Replacement Instructions	4-6
	Adjustment Procedures.....	4-7
	Accessory Test Connector	4-8
CHAPTER 5	SCHEMATIC DIAGRAMS.....	5-1
	General.....	5-1

		Paragraph	Page
APPENDIX			
A	REFERENCES.....		A-1
B	COMPONENTS OF END ITEM LIST.....		B-1
C	ADDITIONAL AUTHORIZATION LIST.....		C-1
D	MAINTENANCE ALLOCATION.....		D-1
E	EXPENDABLE SUPPLIES AND MATERIALS LIST.....		E-1
F	REPAIR PARTS AND SPECIAL TOOLS LIST.....		F-1

LIST OF ILLUSTRATIONS

Fig. No.	Title	Page
1-1	Signal Generator AN/URM-206.....	1-2
2-1	Outline Installation Drawing.....	2-1
2-2	Operating Controls, Indicators and Connectors.....	2-3
2-3	Packaging Diagram.....	2-9
3-1	Signal Generator SG-1145/URM, Block Diagram.....	3-2
3-2	High Voltage Generator, Block Diagram.....	3-5
3-3	MD-1075/URM, Block Diagram.....	3-8
4-1	Modulation Characteristics Test Set-Up.....	4-4
4-2	External Pulse Modulation Test Set-Up.....	4-5
4-3	External Frequency Modulator Test Set-Up.....	4-6
4-4	Internal Synchronization Test Set-Up.....	4-7
4-5	External Synchronization Sine Wave Test Set-Up.....	4-8
4-6	Signal Generator SG-1145/URM Chassis, Top View.....	4-17
4-6.1	Signal Generator SG-1145/URM Chassis, Top View, Serial No. 5-201B thru 5-511B.....	4-18
4-7	Signal Generator SG-1145/URM-206 Chassis, Rear View.....	4-18.1
4-8	Signal Generator SG-1145/URM-206 Chassis, Side View.....	4-18.2
4-9	Pushbutton Board Assembly 1A3, Component Location, Top View.....	4-19
4-9.1	Pushbutton Board Assembly 1A3, Component Location, Top View, Serial Nos. 5-201B thru 5-511B.....	4-20
4-10	Pushbutton Board Assembly 1A3, Component Location, Bottom View.....	4-21
4-10.1	Pushbutton Board Assembly 1A3, Component Location, Bottom View, Serial Nos. 5-201B thru 5-511B.....	4-22
4-11	High Voltage Control Board Assembly 1A4, Component Layout.....	4-22.1
4-12	High Voltage Control Board Assembly 1A5, Component Layout (2 Sheets).....	4-23
4-13	Tracking Board Assembly 1A6, Component Layout.....	4-25

Fig. No.	Title	Page
4-14	400-60 Hz Converter Board 1A10, Component Layout	4-26
4-15	Modulator MD-1075/URM, Top View	4-27
4-16	Modulator Component Board, Component Layout	4-28
5-1	Signal Generator SG-1145/URM, Schematic Diagram	5-3
5-1.1	Signal Generator SG-1145/URM, Schematic Diagram Serial No. 5-201B thru 5-511B.....	5-4.1
5-2	Pushbutton Board Assembly 1A3, Schematic Diagram.....	5-5
5-2.1	Pushbutton Board Assembly 1A3, Schematic Diagram Serial No. 5-201B thru 5-511B.....	5-6.1
5-3	High Voltage Control Board Assembly 1A4, Schematic Diagram	5-7
5-4	High Voltage Box Assembly 1A5, Schematic Diagram.....	5-9
5-5	400 To 60 Hz Converter Board 1A10, Schematic Diagram	5-11
5-6	Modulator MD-1075/URM, Schematic Diagram.....	5-13

LIST OF TABLES

Table	Title	Page
1-1	List of Items Comprising an Operable Equipment	1-4
1-2	Technical Characteristics	1-5
2-1	Operating Controls, Indicators and Connectors	2-4
4-1	List of Test Equipment.....	4-2
4-1.1	Periodic Inspection	4-3
4-2	Troubleshooting Chart.....	4-10
4-3	Voltage Measurements During CW Operation.....	4-33
5-1	Voltage and Resistance Measurements	5-15

CHAPTER 1

INTRODUCTION

Section I. GENERAL

1.1. SCOPE

This manual describes Signal Generator AN/URM-206 Serial Numbers 2-60A thru 2-117A (Fig. 1-1) and Signal Generator AN/URM-206 Serial Numbers 5-201B thru 5-511B and provides instructions for installation, operation and maintenance. It includes instructions for cleaning and inspection of the equipment and replacement of parts available to organizational repair personnel. It also includes instructions for troubleshooting, testing, and repairing the equipment, as well as tools, materials, and test equipment required by general support personnel.

Unless otherwise indicated, all information provided for Signal Generator AN/URM-206 Serial Numbers 2-60A thru 2-117A is also applicable to Signal Generator Serial Numbers 5-201B thru 5-511B.

1-2. CONSOLIDATED INDEX OF ARMY PUBLICATIONS AND BLANK FORMS

Refer to the latest issue of DA PAM 25-30 to determine whether there are new editions, changes, or additional publications pertaining to the equipment.

1-3. MAINTENANCE FORMS, RECORDS, AND REPORTS

a. Reports of Maintenance and Unsatisfactory Equipment. Department of the Army forms and procedures used for equipment maintenance will be those prescribed by DA PAM 750-8, The Army Maintenance Management System (TAMMS) Users Manual.

b. Report Packaging and Handling Deficiencies. Fill out and forward SF 364 (Report of Discrepancy (ROD)) as prescribed in AR 735-11-2/DLAI 4140.55/SECNAVIST 4355.18A/AFJMAN 23-215.

c. Transportation Discrepancy Report (TDR) (SF 361). Fill out and forward Transportation Discrepancy Report (TDR) (SF 361) as prescribed in DA PAM 25-30

1-4. REPORTING EQUIPMENT IMPROVEMENT RECOMMENDATIONS (EIRs)

If your Signal Generator AN/URM-206 needs improvement, let us know. Send us on EIR. You, the user, are the only one who can tell us what you don't like about your equipment. Let us know why you don't like the design. Tell us why a procedure is hard to perform. Put it on an SF 368 (Product Quality Deficiency Report). Mail it to Commander, US Army Aviation and Missile Command, AMSAM-MMC-MA-NM, Redstone Arsenal, AL 35898-5000. We will send you a reply.

1-5. ADMINISTRATIVE STORAGE

There is no special procedure for preparing this equipment for limited storage. Place all ancillary items in a bag and tie and tape the bag to the equipment. Place equipment in limited storage, i.e., organizational storage room. Protect equipment from dust, humidity, and extreme temperature changes.

1-6. DESTRUCTION OF ARMY ELECTRONICS MATERIEL

Destruction of electronics materiel to prevent enemy use shall be in accordance with TM 750-244-2.

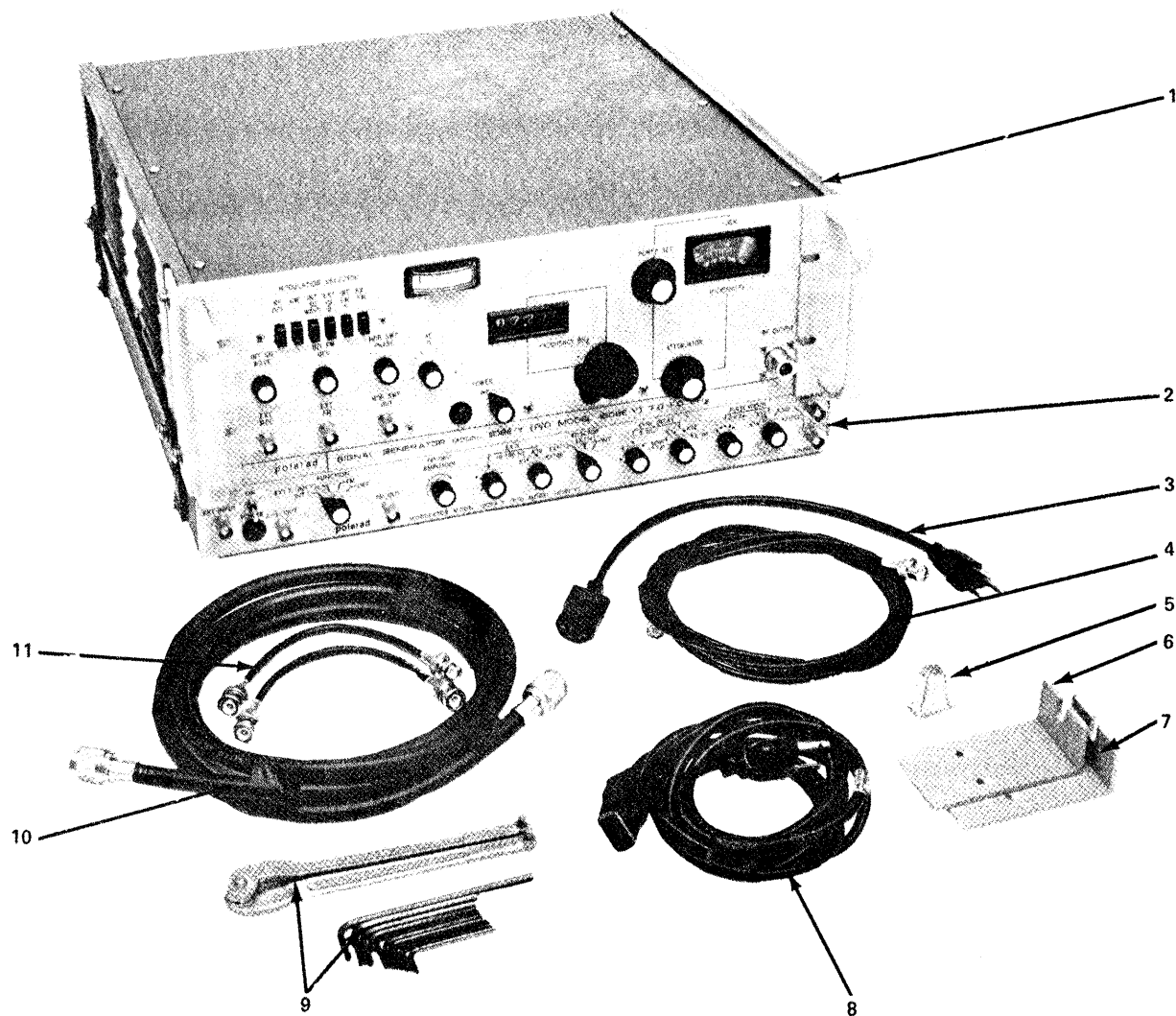

EL5YQ-1

Figure 1-1. Signal Generator AN/URM-206

Section II. DESCRIPTION AND DATA

1-7. PURPOSE AND USE

a. Purpose. Signal Generator AN/URM-206 (Fig. 1-1) is a general purpose broad band signal generator with a frequency range of 7.0 to 11.0 GHz. It provides spectrally pure CW signals and includes facilities for FM, square wave and widely adjustable pulsed outputs. The CW signals of the instrument are directly calibrated from -127 dBm to 0dBm.

b. Use. Typical uses of Signal Generator AN/URM-206 is as a reference signal generator to test broad- and/or narrow band microwave systems such as antennas, attenuators, beacons, crystal mounts, hybrid structures, preselectors, radars, receivers, and TWT amplifiers. The signal generator can be used to make specific measurements such as bandwidth insertion loss, frequency calibration, image reflection ratio, sensitivity, signal to noise ratio, VSWR, FM, square wave, and pulsed modulation tests. It incorporates phase lock provisions to increase frequency stability when used with an external frequency stabilizer. The signal generator also has a provision for external motor drive for tuning through the rear panel. The modulator outputs can be used to modulate other instruments simultaneously with their use in the AN/URM-206. The Modulator MD-1075/URM (Fig. 1-1) provides amplitude and FM for signal generators, signal sources, and oscillators. It provides pulse,

square wave and sawtooth outputs, and delayed or undelayed sync pulses for synchronization.

1-8. DESCRIPTION OF EQUIPMENT

The Signal Generator AN/URM-206 is suitable for bench or rack use. The Modulator MD-1075/URM and Signal Generator SG-1145/URM used in the AN/URM-206 are AC line powered. The AN/URM-206 is 7 in. high, 16-3/4 in. wide, and 17 in. deep. Operating controls, indicators and connectors are mounted on the front and rear panels. The handles at either end of the signal generator front panel are reversible for bench and rack use. The dust covers which are side, top, and bottom panels, enclose and protect the internal components.

1-9. ITEMS COMPRISING AN OPERABLE EQUIPMENT

The items that comprise the operable equipment of Signal Generator AN/URM-206 are listed in Table 1-1 and illustrated in Figure 1-1.

1-10. TECHNICAL CHARACTERISTICS

The technical characteristics of Signal Generator AN/URM-206 are listed in Table 1-2.

TABLE 1-1. LIST OF ITEMS COMPRISING AN OPERABLE EQUIPMENT

FIGURE 1-1

ITEM NO.	QTY	ITEM	PART NUMBER
1	1	SIGNAL GENERATOR (NSN 6625-01-077-8502)	SG-1145/URM
2	1	MODULATOR (NSN 6625-01-077-8577)	MD-1075/URM
3	1	POWER JUMPER CORD	B160826
4	1	VIDEO CABLE ASSEMBLY	B12553
5	1	TEST CONNECTOR	A713772
6	1	BRACKET,RACK MOUNT	A165931-1
7	1	BRACKET,RACK MOUNT	A165931-2
8	1	POWER CABLE	B160833
9	1	WRENCH KIT	A25109
10	1	RF CABLE ASSEMBLY	B12551
11	2	VIDEO CABLE ASSEMBLY	C147363

TABLE 1-2. TECHNICAL CHARACTERISTICS

Characteristic	Specification
Frequency Range	7.0 to 11.0 GHz
Δ F Control Range	1.5 MHz
Accuracy	$\pm 1\%$ of indicated frequency
Response	The output power level shall not vary more than 3 dB over any frequency band or when the output is switched from pulse modulated to unmodulated CW
VSWR	2:1 maximum
RF Output Signals	CW, sawtooth FM pulse modulated (PM), and square wave modulated outputs
Output Power	Continuously variable from 0 to -127 dBm
Output Power Indication Error	< ± 2 dB of the indicated value for outputs from -7 dBm to -127 dBm < ± 3 dB of the indicated value for outputs from 0 to -7 dBm
Output Impedance	50 ohms nominal
Internal Pulse Modulation	
Pulse Rate	40 to 4000 pps, continuously adjustable
Pulse Width	0.5 to 10 microseconds, continuously variable
Rise and Fall Time	<0.2 microseconds
External Pulse Modulation	
Amplitude	20 to 70 volts peak
Polarity	Positive or negative
Width	0.5 to 2500 microseconds with pulse separation from 1.5 to 2500 microseconds
Rise and Fall Time	<0.2 microseconds
Internal FM	
Rate	40 to 4000 Hz, continuously adjustable
Deviation	0 to 5 MHz
Square Wave Modulations	40 to 4000 Hz, continuously adjustable
Output Attenuation	0 dBm (233 millivolts) to -127 dBm (0.1 microvolt)

TABLE 1-2. TECHNICAL CHARACTERISTICS (Continued)

Characteristic	Specification
Distortion	
Spurious Signals	At least 60 dB below the power of the desired R F test signal
Harmonics	At least 30 dB below the power of the desired RF test signal
Residual FM	Deviation up to 15 kHz peak
Residual AM	Shall not exceed 0.5%
Internal Synchronization	
Amplitude	25 to 100 volts, positive
Width	5 microseconds, maximum
External Synchronization	
Sine Wave	Any external sine wave signal from 40 Hz to 4000 Hz having an amplitude from 5 to 50 volts rms. will synchronize the generator
Pulse Signal	Any external pulse signal from 40 to 4000 pulses per second, a pulse width from 0.5 to 5 microseconds, and a peak amplitude within the range of 5 to 50 volts will synchronize the generator
Synchronization Delay	3 to 300 microseconds, continuously adjustable
Output Signals	Sawtooth, delay, undelayed, FM, and pulse
Output Connector	Type N
Power Requirements	115/230 volts, 50-60 and 400 Hz, 250 watts
Dimensions	7" H x 16-3/4" Wx 17" D
Weight	50 pounds

CHAPTER 2

INSTALLATION AND OPERATION

2-1. GENERAL

Signal Generator AN/URM-206 is shipped complete and ready to operate; no special or permanent installation procedures are required. The signal generator shall be unpacked upon receipt, observing the usual precautions customary when unpacking an electronic instrument.

2-2. INSTALLATION

After unpacking plan its installation. If it will be used on a bench or cart, the required dimensions are shown in Figure 2-1. If it is to be used in a rack, the handles at either end of the front panel should be reversed for rack mounting as shown in Figure 2-1. The signal generator requires 115/230 volts, single phase, 50/60, 400 Hz ac power.

NOTE

AN/URM-206 is shipped ready for 115 vac operation. If the signal generator is to be operated from a 230-volt source, set the 115/230 volt switch located on the rear panels of the SG-1145/URM and MD-1075/URM to the 230 volt position. Replace the fuse in the SG-1145/URM with the 0.75 amp fuse and the fuse in MD-1075/URM with the 1/8 amp fuse.

2-3. OPERATING CONTROLS, INDICATORS AND CONNECTORS

The operating controls, indicators, and connectors of the AN/URM-206 are listed in Table 2-1 and shown in Figure 2-2.

2-4. OPERATION

a. Connect power cable B160826 between the AC OUTPUT connector of the modulator and the AC INPUT connector of the signal generator.

b. Set the POWER switches of the modulator and the signal generator to their OFF positions.

c. Connect video cable C147363 between the  OUT connector on the modulator and the EXT MOD connector on the signal generator.

d. Connect the other video cable C147363 between the FM OUT connector on the modulator and the EXT FM connector on the signal generator.

e. Connect power cable B160833 between the AC INPUT connector of the modulator and the external ac power source.

f. Turn the POWER switches on the modulator and the signal generator to ON and allow the instruments to warm up for 20 minutes. Power indicator on the signal generator and the POWER ON indicator lamp on the modulator should light indicating power is being applied.

2-5. CW OPERATION

a. Set the FREQUENCY GHz control of the signal generator to the desired frequency.

b. Set the FUNCTION switch of the modulator to OFF.

c. Set the MODULATION SELECTOR switch of the signal generator to CW.

NOTE

It is possible to make the signal generator inoperative by driving the attenuator probe too far into the oscillator cavity of the signal generator. If this occurs, back off the attenuator by turning the ATTENUATOR control counterclockwise and switch the MODULATOR SELECTOR switch to RF OFF and then repeat steps a, b, and c above.

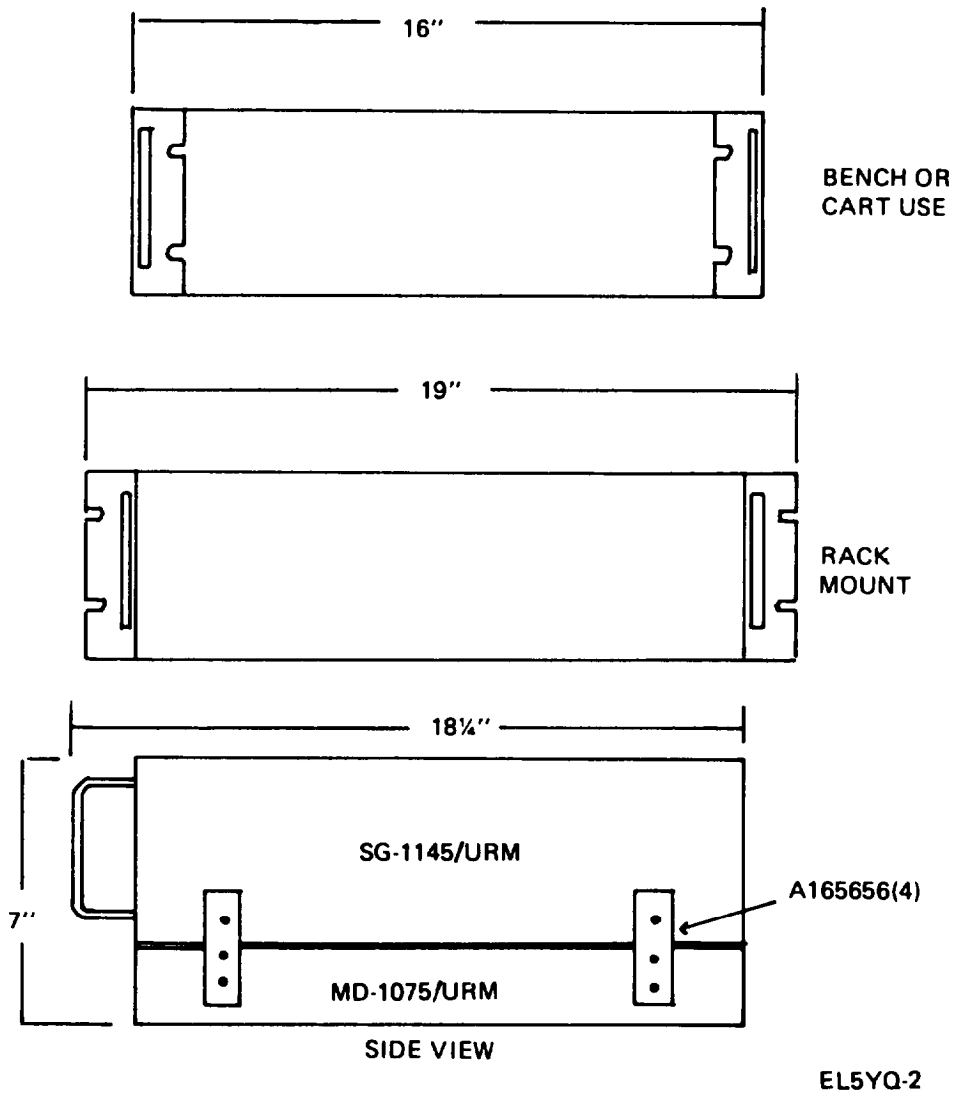
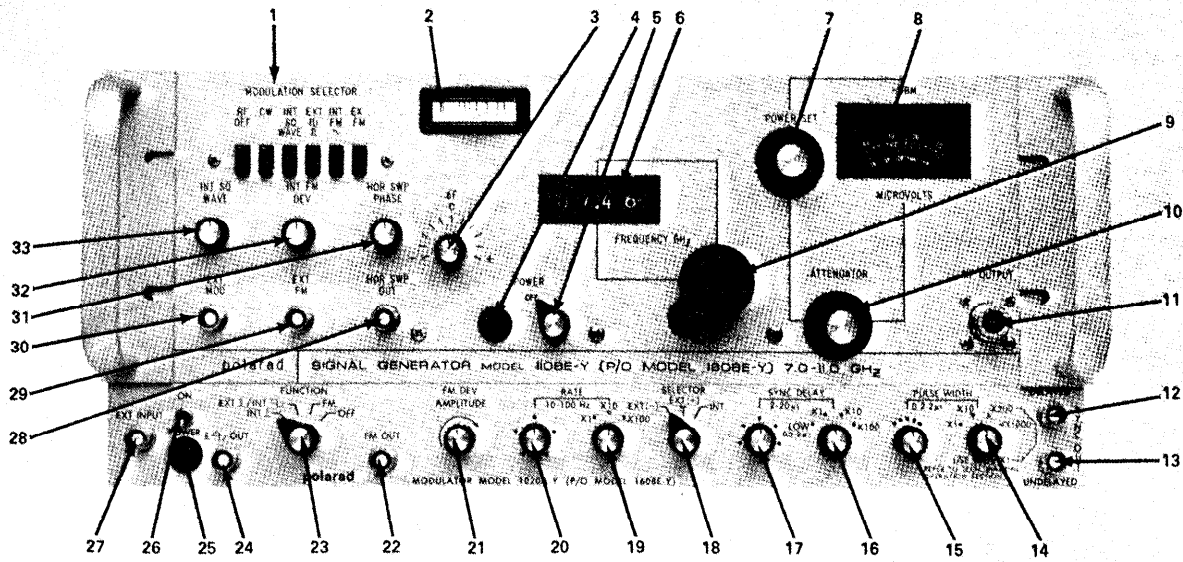

Figure 2-1. Outline Installation Drawing

d. Adjust the POWER SET control of the signal generator for a reading of CAL on the power monitor meter.

e. Adjust the ATTENUATOR control to read the desired output power level on the attenuator dial.



EL5YQ-3

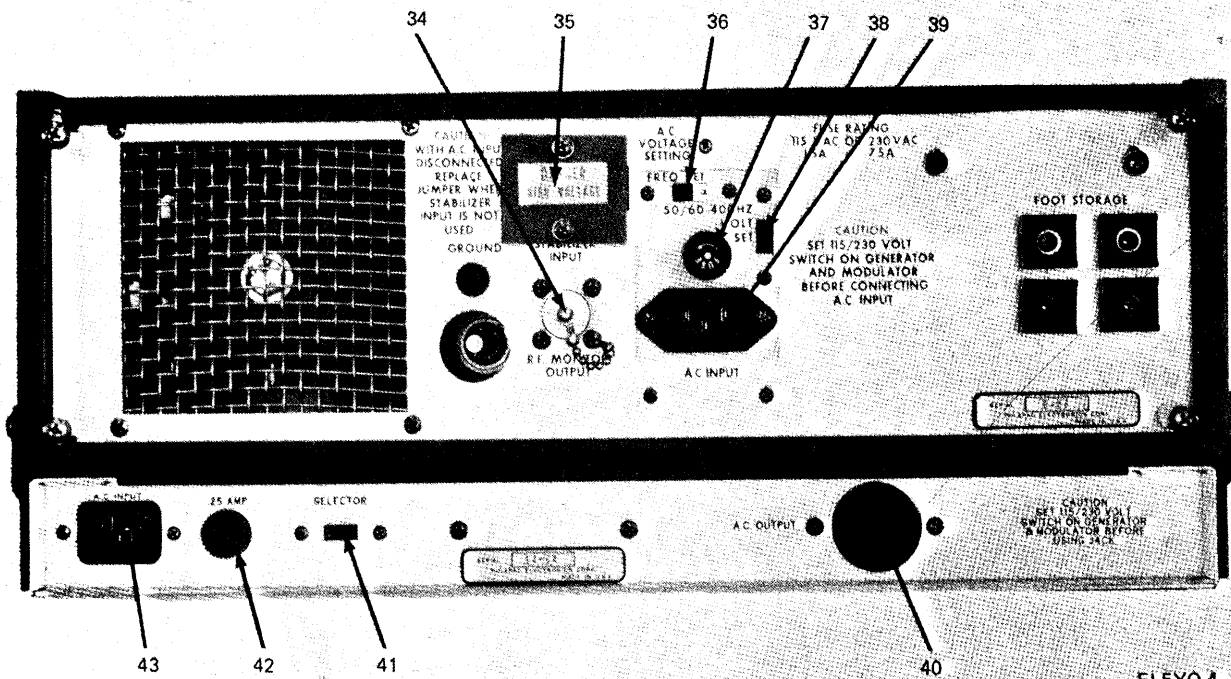

EL5YQ-4

Figure 2-2. Operating Controls, Indicators and Connectors

TABLE 2-1. OPERATING CONTROLS, INDICATORS, AND CONNECTORS

Figure 2-2 Item No.	Control, Indicator, or Connector	Function
1	MODULATOR SELECTOR switch	Selects type of modulation as follows: RF OFF . . . Disables rf output, standby position CW No modulation present INT SQ WAVE Square wave modulation internal to SG-1145/URM EXT  Pulse modulation external to SG-1145/URM INT FM FM modulation internal to SG-1145/URM EXT FM FM modulation external to SG-1145/URM
2	Power Monitor Meter	Used to set power level of signal generator for attenuator calibration
3	ΔF control	Fine frequency control. May be used to maximize system power output and control pulse jitter
4	Power indicator lamp	Lights when ac power is applied to the signal generator
5	POWER switch	Controls application of ac power
6	FREQUENCY GHz dial	Displays digital frequency readout of the signal generator frequency
7	POWER SET control	Used to adjust oscillator power level for power monitor meter indication of CAL
8	Attenuator dial	Displays readout in dBm and microvolt of attenuator output at the RF OUTPUT connector when the power monitor meter is set to CAL
9	Frequency GHz control	Adjusts instrument frequency
10	ATTENUATOR control	Adjusts power level of the signal generator
11	RF OUTPUT connector	RF output available for use
12	DELAYED SYNC OUT connector	Provides positive video trigger pulse in time coincidence with leading edge of rf output pulse

TABLE 2-1. OPERATING CONTROLS, INDICATORS, AND CONNECTORS (Continued)

Figure 2-2 Item No.	Control, Indicator, or Connector	Function								
13	UNDELAYED SYNC OUT connector	Provides positive video trigger pulse which leads both rf output pulse and delayed sync output pulse in time								
14, 15	PULSE WIDTH control and X1-X10-X200-X1000 switch	<p>Adjusts rf output pulse from 0.2 to 2000 μsec</p> <table border="0" data-bbox="910 453 1362 575"> <tr> <td>X1</td> <td>0.2 to 2 μsec</td> </tr> <tr> <td>X10</td> <td>2.0 to 20 μsec</td> </tr> <tr> <td>X200</td> <td>40 to 400 μsec</td> </tr> <tr> <td>X1000</td> <td>200 to 2000 μsec</td> </tr> </table> <p>Pulse width range overlap on the X10 and X200 multiplier positions provides pulse width from 20 μsec to 40 μsec</p>	X1	0.2 to 2 μ sec	X10	2.0 to 20 μ sec	X200	40 to 400 μ sec	X1000	200 to 2000 μ sec
X1	0.2 to 2 μ sec									
X10	2.0 to 20 μ sec									
X200	40 to 400 μ sec									
X1000	200 to 2000 μ sec									
16, 17	SYNC DELAY control and LOW-X1-X10-X100 multiplier	Adjusts delay between both rf output pulse and delayed sync output pulse from 0.3 to 2000 μ sec								
18	SELECTOR switch	<p>Enables modulating output signals to be either internally or externally controlled. For external modulating signals, the controls are set as follows:</p> <ol style="list-style-type: none"> a. Must be set to EXT(+) when a positive synchronizing pulse or a positive modulating pulse is externally applied. b. Must be set to EXT(-) when a negative synchronizing pulse or a negative modulating pulse is externally applied. c. May be set to EXT(+) or EXT(-) when a sine wave synchronizing signal is externally applied. 								
19, 20	X1-X10-X100 multiplier switch and RATE control	Adjust pulse repetition rate from 10 to 10,000 Hz								
21	FM DEV AMPLITUDE control	When FUNCTION switch is in the FM position, adjusts the amplitude of the output sawtooth. (Adjusts deviation of rf outputs when MODULATION SELECTOR switch is set to EXT FM position.)								
22	FM OUT connector	When FUNCTION switch is in FM position, couples internally generated sawtooth waveform to EXT FM connector.								
23	FUNCTION switch	Selects internal pulse, internal square wave, internal FM, external pulse modulation, or no modulation								
24	 OUT connector	Couples output pulse or output square wave to EXT MOD input connector on SG-1145/URM								

TABLE 2-1. OPERATING CONTROLS, INDICATORS, AND CONNECTORS (Continued)



Figure 2-2 Item No.	Control, Indicator, or Connector	Function
25	POWER ON indicator lamp	Lights when ac power is applied to the Modulator MD-1075/URM.
26	POWER switch	Controls application of ac power to Modulator MD-1075/URM.
27	EXT INPUT connector	Connects Modulator MD-1075/URM to either externally synchronizing or externally pulse modulating signals
28	HOR SWP OUT connector	Output for horizontal sweep signal to oscilloscope
29	EXT FM connector	Accepts fm signal external to Model SG-1145/URM
30	EXT MOD connector	Accepts pulse or square wave modulation signal external to Model SG-1145/URM.
31	HOR SWP PHASE control	Controls phase of horizontal sweep signal to oscilloscope.
32	INT FM DEV control	Adjusts amplitude of FM driving signal internal to Model SG-1145/URM.
33	INT SQ WAVE control	Adjusts square wave frequency over the minimum range of 950 to 1050 Hz.
34	RF MONITOR OUTPUT connector*	Used for automatic frequency stabilization or auxiliary RF output.
35	STABILIZER INPUT terminals*	Used for automatic frequency stabilization or other auxiliary use
36**	FREQ SET 50/60-400 Hz switch*	Sets 50/60 Hz or 400 Hz.
	FUSE*	Circuit protection for SG-1145/URM.
38	AC VOLTAGE SETTING switch*	Sets either 115 vac or 230 vac.
39	POWER INPUT connector*	Power cord input connection.
40	AC OUTPUT connector*	Connection for ac power between SG-1145/URM and MD-1075/URM.
41	SELECTOR switch*	Selects either 115 vac or 230 vac on Model MD-1075/URM.
42	.25 AMP fuse*	Circuit protection for MD-1075/URM.
43	AC INPUT connector*	Connection for ac power.

*Located on rear panel.

**Serial Numbers 2-60A thru 2-117A Only



2-6. INTERNAL SQUARE WAVE MODULATION OPERATION

Perform steps a. through e. of paragraph 2-5 and proceed as follows:

- a. Set the FUNCTION switch of the modulator to EXT  / INT .
- b. Set the SELECTOR switch of the modulator to INT.
- c. Set the MODULATION SELECTOR switch of the signal generator to EXT .
- d. Adjust the RATE control of the modulator for the desired rate.



2-7. INTERNAL PULSE MODULATION OPERATION

Perform steps a. through e. of paragraph 2-5 and proceed as follows:

- a. Set the FUNCTION switch of the modulator to INT .
- b. Set the SELECTOR switch of the modulator to INT.
- c. Set the MODULATION SELECTOR switch of the signal generator to EXT .
- d. Adjust the RATE and PULSE WIDTH controls of the modulator for the desired pulse rate and width.

2-8. EXTERNAL PULSE MODULATION OPERATION

Perform steps a. through e. of paragraph 2-5 and proceed as follows:

- a. Set the FUNCTION switch of the modulator to EXT  / INT .
- b. Select the SELECTOR switch of the modulator to EXT(+) or EXT(-) as determined by the externally applied pulse polarity.
- c. Set the MODULATION SELECTOR switch of the signal generator to EXT .
- d. Connect the external modulating signal to the EXT INPUT connector of the modulator.

NOTE

Undelayed or delayed sync out signals are available at the DELAYED SYNC OUT connector and/or the UNDELAYED SYNC OUT connector of the modulator.

2-9. INTERNAL FM OPERATION (Internal to SG-1145/URM)

Perform steps a. through e. of paragraph 2-5 and proceed as follows:

- a. Set the MODULATION SELECTOR switch of the signal generator to INT FM ~.
- b. Adjust the INT FM DEV control to obtain the desired sweep width.

2-10. INTERNAL FM OPERATION (AN/URM-206)

Perform steps a. through e. of paragraph 2-5 and proceed as follows:



- a. Set the MODULATION SELECTOR switch of signal generator SG-1145/URM to EXT FM.
- b. Set the FUNCTION switch to FM and the SELECTOR switch to INT on modulator MD-1075/URM.
- c. Adjust the RATE control and multiplier switch X1, X10, X100 on modulator MD-1075/URM for the desired modulation rate.
- d. Adjust the FM DEV AMPLITUDE control for the desired deviation.

2-11. EXTERNAL FM OPERATION

a. Connect the external modulating signal to the EXT FM connector.

- b. Perform steps a. through e. of paragraph 2-5.
- c. Set MODULATION SELECTOR switch of the signal generator to EXT FM.
- d. Set FUNCTION switch of the modulator to OFF.
- e. Set the external FM source to desired characteristics.

2-12. EXTERNAL SYNCHRONIZATION

- a. Perform steps a. through e. of paragraph 2-5.
- b. Connect the external synchronizing signal to the EXT INPUT connector of the modulator.
- c. Set the SELECTOR switch of the modulator to either EXT(+) for a positive input or EXT(-) for a negative input pulse signal and to either EXT(+) or EXT(-) for sine wave signal.
- d. Set the FUNCTION switch to INT .
- e. Set MODULATION SELECTOR switch to EXT .

2-13. PACKAGING INSTRUCTIONS

- a. Packaging for Short Term Storage. If the Signal Generator AN/URM-206 is to be stored for a relatively short period, cover it with a suitable protective covering such as a sheet of plastic or paper. Put the accessories and instruction manual in an envelope or bag and fasten it to the AN/URM-206 to prevent loss. Store in a clean and dry area where it will not be subjected to extreme temperatures. Save the packing material for future, safe shipping requirements.
- b. Packing for Long Term Storage or Shipment. If the AN/URM-206 is to be stored for a long time or shipped, proceed as follows: Save the original wrappings and carton and re-package the instrument in them. The original packing material properly cushions the instrument for shipment. See Figure 2-3.

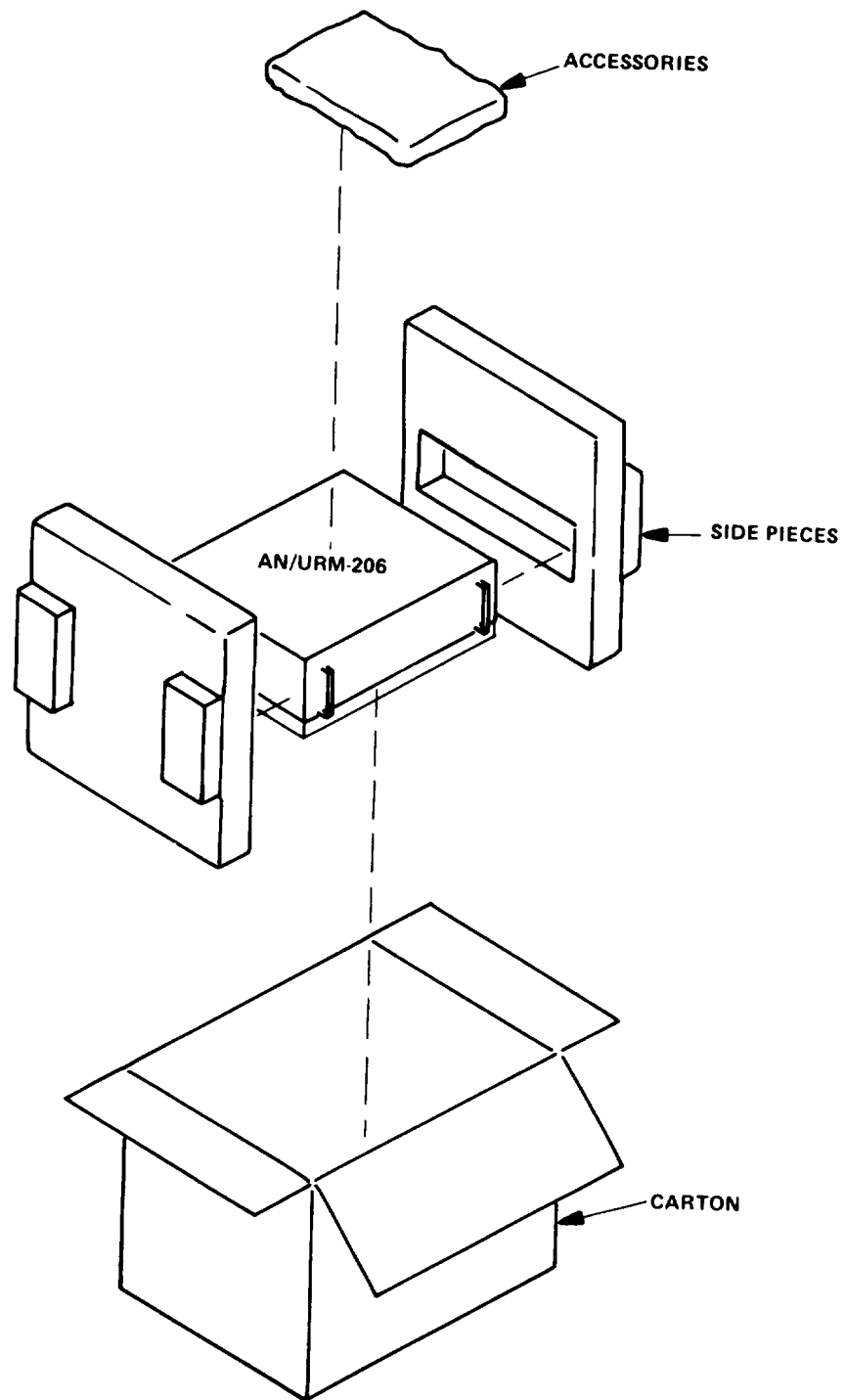

EL5YQ-5

Figure 2-3. Packaging Diagram

CHAPTER 3

FUNCTIONING OF EQUIPMENT

3-1. GENERAL

The Signal Generator AN/URM-206 provides spectrally-pure accurately calibrated signals from 7.0 to 11.0 GHz. It consists of Signal Generator SG-1145/URM (top assembly) and Modulator MD-1075/URM.

3-2. SIGNAL GENERATOR SG-1145/URM

The SG-1145/URM is a signal-generating device that employs a klystron oscillator with an external cavity to generate rf energy. The frequency range of the signal generator is from 7.0 to 11.0 GHz, with a ΔF control offering 1.5 MHz fine tuning over the frequency range. The signal generator has a calibrated piston attenuator with a 50 ohm output impedance and offers an output range of 0 to - 127 dBm.

3-3. BLOCK DIAGRAM ANALYSIS, SIGNAL GENERATOR SG-1145/URM

The signal generator, Fig. 3-1, consists of nine principal circuit elements: a klystron oscillator, its repeller tracking system, a beam power supply, a repeller power supply, a 40V power supply for modulation circuits, a Schmitt trigger, a square wave generator, a line frequency sine wave voltage circuit, and an amplifier circuit. The klystron oscillator employs a reflex klystron tube that is mounted into an external coaxial cavity, which is tuned to resonance by a non-contacting short tuning plunger driven by the FREQUENCY GHz control. The frequency drive system also operates the digital readout frequency dial and the tracking system, which selects the proper repeller mode and adjusts the repeller voltage for the frequency selected. The power supplies are completely solid-state using monolithic linear integrated circuits as precision voltage regulators. The Schmitt trigger followed by the amplifier delivers the square wave and pulses to the klystron oscillator. The square wave generator is a D-type flip-flop (1A3U4) whose variable frequency is controlled by a timer (1A3U3) from 950 to 1050 Hz, minimum. The signal generator incorporates a power monitoring circuit that enables the attenuator

to be calibrated directly in dBm and microvolt. The power set drive system moves the power probe and the hairline of the attenuator dial. The power monitor probe couples rf power from the klystron cavity to the crystal detector and power monitor meter. When the POWER SET control is adjusted for a power monitor indication of CAL, the power monitor probe is coupled to approximately 1 milliwatt power level. The ATTENUATOR control operates the attenuator probe and the dBm-microvolts dial to provide a calibrated rf output.

The signal generator incorporates a provision for automatic frequency stabilization. A sample of power in the klystron oscillator is fed to an external control system and the output of the external control system is fed to the klystron repeller as a stabilizer input (correction voltage) which is superimposed on the repeller voltage.

3-4. SIGNAL GENERATOR SG-1145/URM CIRCUIT ANALYSIS

See Figures 3-1, 5-1 through 5-5.

3-5. KLYSTRON OSCILLATOR (Fig. 5-1 and 5-1.1)

A klystron oscillator (1V1) provides the rf power output. It is velocity-modulated, operating in an external resonant coaxial transmission line and consists of two conductors, one inside the other. The klystron is mounted at one end of the cavity with the outer cylinder making contact with the first grid and the inner conductor making contact with the second resonator grid. The resonant circuit is completed at the other end of the cavity by a moveable non-conducting shorting plunger. The position of this plunger determines the resonant frequency of the cavity. The frequency of oscillation of the klystron oscillator is determined by the resonant frequency of the cavity and the magnitude of the repeller voltage. For a given setting of the cavity, there is an optimum repeller voltage that will cause the bunched electrons to return to the resonator grids at the proper time. The repeller voltage, therefore, cannot remain the same over the frequency range of the oscillator.

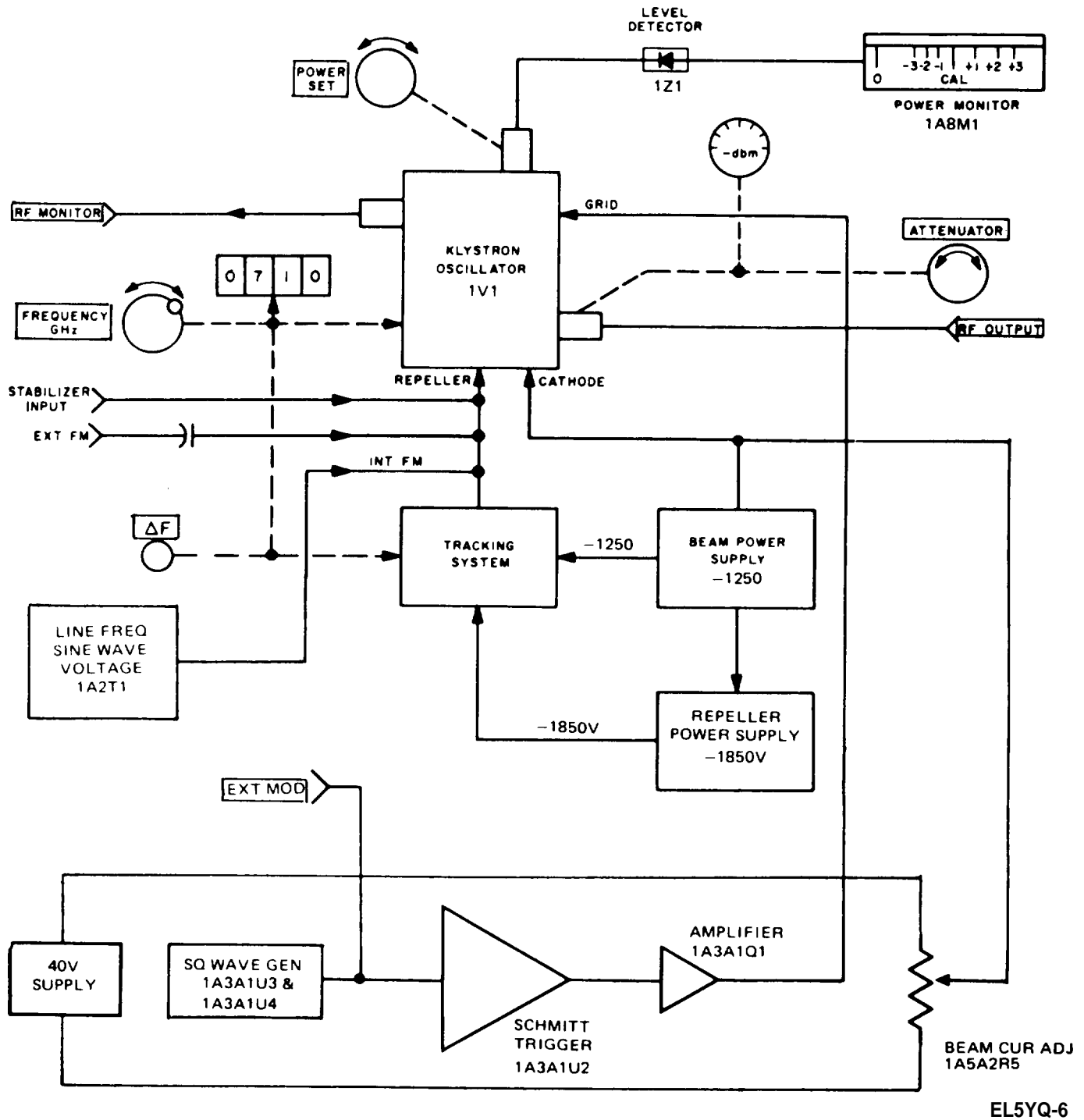

Figure 3-1. Signal Generator SG-1145/URM Block Diagram

In order to produce oscillation over the frequency range of the oscillator, a tracking arrangement is used to vary the dc voltage on the repeller so that it is maintained at the optimum value for a given plunger setting

3-6. MODE SWITCHING (Fig. 5-1)

At a certain frequency value (8.15 GHz), the repeller voltage becomes excessively high and it is more practical to change the repeller voltage to a new range. This can be done without changing the frequency of the oscillation at a given cavity setting by lowering the repeller voltage so that the tube operates in a higher mode. In the higher mode the bunched electrons require a longer time in cycles to be returned to the resonator grids. It operates in the 2% and 4% modes. The switching arrangement is described in paragraph 3-7. The oscillator cavity is coupled through two probes; the attenuator probe with a variable amount of insertion that determines the rf power level delivered to the RF OUTPUT connector, and the fixed rf monitor probe that supplies the power sample for automatic frequency stabilization. Model SG-1145/URM incorporates a third power monitor probe, with a variable amount of insertion, that supplies power to the monitoring circuit for calibrating the output attenuator.

3-7. REPELLER VOLTAGE TRACKING SYSTEM (Fig. 5-1)

The dc voltage applied to the repeller is controlled by tracking potentiometer (1A7R1). The movement of the arm of 1A7R1 is mechanically ganged with the movement of the tuning plunger in the klystron cavity so that the repeller voltage is maintained at the optimum value for the maximum amplitude of oscillation. Repeller mode switch 1A7S1 is operated by a cam driven by the tuning drive and changes the voltage applied to 1A7R1 so that a different mode can be used. The values of the resistors in the tracking circuit are calculated for the proper frequency-vs-voltage characteristic. Adjustment potentiometers are provided in the tracking circuit to compensate for variation in klystron repeller voltage characteristics. The maximum voltage across tracking potentiometer 1A7R1 is 600 v, since it is connected from the -1250 volt beam supply to the -1850 volt repeller supply. The cathode of klystron 1V1 is connected to the -1250 volt beam supply and therefore the repeller voltage can vary from 0 to -600 volts.

NOTE

The Δf control (1A3R28) provides a small variation in the repeller voltage, which produces a vernier frequency variation of at least 1.5 MHz.

3-8. PROTECTIVE DIODE (Fig. 5-2)

Protective diode (A3A1CR4) is connected between the cathode and repeller of klystron (1V1) to prevent the repeller from becoming more positive than the cathode which would damage the klystron.

3-9. FREQUENCY CONTROL KNOB (Fig. 3-1)

The frequency control knob rotates the shaft which drives the digital readout, the cam that positions the tuning plunger, and the tracking potentiometer, each through the appropriate gearing. The shaft extends through the tuning mechanism casting to the rear of the instrument where it can be attached to an external motor drive, if required.

3-10. CALIBRATED ATTENUATION OPERATION (Fig. 3-1)

Power from the klystron cavity is coupled through two symmetrical pipes into two matched waveguide-beyond-cutoff attenuators. The POWER SET control positions the power set probe in its pipe. The power set probe couples rf power from the klystron cavity to the crystal detector and the power monitor meter and also moves the hairline of the attenuator dial. When the POWER SET control is adjusted for a power monitor meter indication of CAL, the power set probe is coupled to approximately 1 milliwatt power level. Should the energy level within the cavity change when the cavity is tuned to a different frequency, the power set probe must be reset to obtain the 1 milliwatt level of power absorption which will bring the power monitor meter back to its reference CAL position. At the same time, the hairline is repositioned to a new 0 dBm reference. When the POWER SET adjustment is set for CAL, the attenuator probe is adjusted for 0 dBm output at the same time that the attenuator dial is adjusted for 0 dBm under the hairline. In this way, as frequency is varied, and the power monitor meter is set for CAL by placing the attenuator dial at 0 dBm under the hairline, the output will be 0 dBm within the specification accuracy.

In order to obtain other levels of power, the ATTENUATOR control is adjusted so that the desired level is under the hairline of the attenuator dial. This adjustment varies the position of the attenuator probe in its waveguide-beyond-cutoff pipe. The rate of attenuation within the pipe follows a rigid physical law and is extremely accurate, thus the rate of attenuation is transcribed into the dial.

3-11. SCHMITT TRIGGER AND AMPLIFIER (Fig. 5-2 and 5-2.1)

The Schmitt trigger 1A3U2 is a gate with fast rise and decay times. The positive voltage to 1A3U2 is held at +12 volts and the negative supply at ground using dropping resistor 1A3R13 and zener diode 1A3CR1. The ground is referenced at -1280V. Diodes 1A3CR2 and 1A3CR3 act as protective diodes for 1A3U2 and 1A3C15 is a speed up capacitor to handle fast pulses. The input to the gate (pin 1) is held at +12V in the CW, INT FM and EXT FM positions and at ground (-1280 volts) in the RF OFF, INT SQ WAVE and EXT  positions via the MODULATION SELECTOR switch (see paragraph 3-14 for more details). The output of the gate (pin 2) is amplified by transistor 1A3Q1 to a suitable level so that the grid of the klystron is biased properly for different modes of operation. In the amplifier circuit 1A3CR5 is a protective diode for 1A3Q1, and 1A3C14 is a speed up capacitor. The amplifier itself acts as an inverter, and the gate 1A3U2 also acts as an inverter; therefore, the logic output of 1A3Q1 is the same as the input of the gate 1A3U2.

3-12. TIME DELAY CIRCUIT (Fig. 5-3)

There is a time delay of approximately 60 seconds when the set is turned on before the beam, repeller and control supply voltages are turned on. This delay is necessary in order that the klystron tube not be damaged. The time delay is accomplished by utilizing integrated circuit 1A4U1. Pin 3 of 1A4U1 is held high (approximately 12 volts) for a period determined by the RC time constant of 1A4R13 and 1A4C7. When 1A4C7 charges to a high enough level, the timer 1A4U1 changes its state at pin 3 from 12 volts to ground, which in turn, changes the output of voltage regulator 1A4U3 so that the oscillations start and all the supplies (-1250, -1850, and 40 V) turn on (see paragraph 3-22 for more details). Zener diode 1A4CR4 and resistor 1A4R14 are used to supply a bias voltage of 12 volts to integrated circuit 1A4U1.

3-13. SQUARE WAVE GENERATOR (Fig. 5-2 and 5-2.1)

Square waves, variable from 950-1050 Hz, are generated using 1A3U3 and 1A3U4. 1A3U4 is utilized as an oscillator

whose frequency is determined by 1A3C17, 1A3R34, 1A3R36, and 1A3R37. The oscillator frequency is adjusted by varying 1A3R36. The oscillator output (pin 3) is fed to the D-type flip-flop 1A3U3 (pin 11). The output frequency of 1A3U3 is 1/2 that of the output of 1A3U4 as characterized by the flip-flop. The output of 1A3U3 (pin 13) is applied to the Schmitt trigger 1A3U2 through the MODULATION SELECTOR switch only in the INT SQ WAVE position. The bias supplies for 1A3U3 and 1A3U4 are tapped from the 40V supply in the same manner as for 1A3U2 (see paragraph 3-11). The bias supply is turned off when the INT SQ WAVE mode of operation is not used.



3-14. MODULATION SELECTION (Fig. 2-2)

The six-position MODULATION SELECTOR switch 1A3S1 selects the proper mode of operation for the various functions. The klystron grid is biased so that it is held positive (approximately 10V) with respect to the cathode in CW, INT FM \sim , and EXT FM positions and is held to cut-off (approximately -30 volts with respect to the cathode) in the RF OFF and EXT  positions. In the INT SQ WAVE position it is switched between +10 and -30 volts. The grid voltage is determined by the adjustment of 1A5R5 which in turn sets the beam current (see paragraph 3-18c). The circuit operation in each positions of the MODULATION SELECTOR which is described in paragraphs a. through f.

a. RF OFF Position (Fig. 2-2). In the RF OFF position, the voltage at the input to the Schmitt trigger gate is returned to ground through the MODULATION SELECTOR switch. The output of the amplifier 1A3Q1 is, therefore, at ground potential (-1280 ref grid) and the grid is thus placed at a negative potential sufficient to drive the klystron into cut-off and thus inhibiting oscillation.

b. CW Position (Fig. 2-2). In the CW position, the voltage at the input to the Schmitt trigger gate (pin 1 of 1A3U2) is held at +12V (with respect to -1280v as referenced ground). The output of the amplifier is thus +40V and the grid is thus placed at a potential that permits the klystron to oscillate.

c. INT SQ WAVE Position (Fig. 2-2). In the INT SQ WAVE position the input to the Schmitt trigger is fed from the output of flip-flop 1A3U3. The square wave output of the flip-flop moves the Schmitt trigger gate up and down at the same rate. The grid driven by the amplifier, therefore, modulates the klystron oscillations, producing a square wave modulation of output. The rate itself, is controlled by the setting of 1A3R36 which changes the frequency of the basic oscillator 1A3U4.

d. EXT  Position. In the EXT  position, the input to the Schmitt trigger gate is placed at ground potential (-1280V) so that initially the klystron tube does not conduct. The input to the Schmitt trigger, however, is driven by positive going pulses from an external source applied at the EXT MOD connector 1J3. The klystron tube conducts only during that portion of the cycle when the pulse fs on.

e. INT FM ~ Position (Fig. 2-2). In the INT FM ~ position the Schmitt trigger is biased so that the output of the amplifier is at +40V; thus, the grid is at a potential so that oscillations in the klystron tube takes place. The voltage on the repeller electrode of the tube is modulated by a sine wave voltage as derived from the line voltage through transformer 1A2T1. The FM deviation is determined by resistor 1A3R16 and the rate is fixed at the line frequency. In addition, a horizontal sweep output is available at connector 1J1 whose phase can be varied by HOR SWP PHASE control resistor 1A3R4. With the use of the HOR SWP OUT and PHASE controls, the rf output modulation can be viewed on an oscilloscope with the aid of an RF detector.

f. EXT FM Position (Fig. 2-2). In the EXT FM position, the oscillations take place as described in the INT FM ~ position. The repeller voltage is modulated by the external voltage applied at connector 1J2.

3-15. ΔF CONTROL (Fig. 2-2)

The ΔF control varies the repeller voltage over a relatively small range to provide a frequency vernier adjustment.

3-16 BEAM (-1250V), REPELLER (-1850V), AND THE +40V (-1280V) REF GROUND POWER SUPPLIES

The power supplies used for the generation of beam, repeller and control circuits are not conventional. A block diagram of the processes by which high voltages are generated is shown in Fig. 3-2. A low voltage dc power supply (+31V) is derived from the ac line voltage using a conventional, step-down transformer 1A2T1, bridge rectifier, and filter networks for low ripple. It supplies the main current for subsequent conversion to a high voltage ac generator. The dc voltage is converted to a low voltage high frequency, ac power source (20 KHz, typical) by oscillator 1A5Q1 and 1A5Q2. The low ac voltage is stepped up to suitable ac voltages by transformer 1A5T2.

a. Low Voltage DC Power Supply. The main ac line voltage is stepped down to approximately 31 vac and rectified using bridge rectifier 1A4BR1. The rectified voltage is filtered and the ripple is kept low using Darlington capacitor multiplier 1A4Q4 and 1A4Q5. Capacitor 1A4C1 provides the fundamental filtering. The effective capacitance of 1A4C2 is increased by the current gains of 1A4Q4 and 1A4Q5.

b. Low Voltage High Frequency AC Voltage Generator (Figs. 5-3 and 5-4). A dc voltage (+31V) described in paragraph 3-16, is converted into low ac voltage at a high frequency as follows. Two PNP transistors 1A5Q1 and 1A5Q2, and transformer 1A5T1 comprise the basic oscillator. The emitter is connected to the +31V dc line through the current limiter 1A4Q1. The bias voltage to the bases is determined by the collector voltage of transistor 1A4Q3.

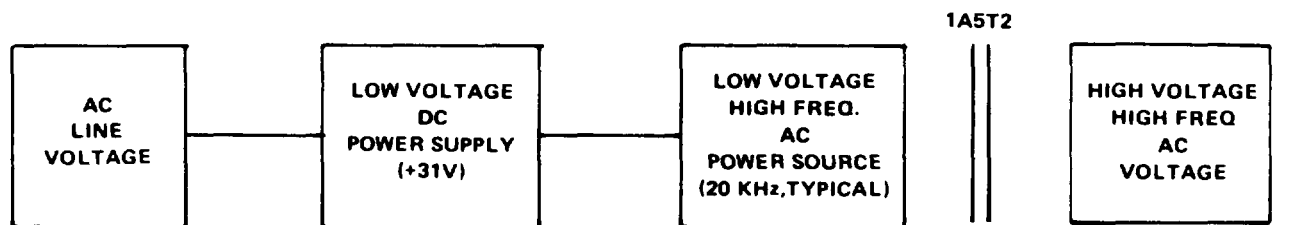

ELSYQ-7

Figure 3-2. High Voltage Generation, Block Diagram

The collector voltage of 1A4Q3 is set initially (before 1A5Q1 and 1A5Q2 oscillate or the time delay is over) by BIAS ADJ resistor 1A4R4. Resistor 1A4R4 is the base-emitter circuit of 1A4Q2; hence it sets the voltage for the collector of 1A4Q2 or emitter of 1A4Q3. Initially the emitter of 1A4Q3 is set as approximately 12V so that 1A5Q1 and 1A5Q2 do not oscillate. (The emitter to base voltage of 1A4Q3 is thus < 0.7 volts.) The base voltage of 1A4Q3 is determined by the output of voltage regulator 1A4U3 which is a monolithic Integrated circuit. The voltage between the NON-INVERTING (pin 3) and INVERTING (pin 2) inputs of 1A4U3 is amplified internally by 1A4U3 and appear at pin 6, which in turn is connected to the base of 1A4Q3 through load resistor 1A4R9. Pin 10 of 1A4U3 is biased with resistors 1A4R16 and 1A4R17 such that the regulator does not regulate initially. The junction of 1A4R16 and 1A4R17 is approximately 0.8V initially. When the delay time is over, this junction voltage changes to zero volts and the regulator starts to regulate. The output at pin 6, which is determined by the voltage difference between pins 2 and 3, is such that 1A4Q3 conducts and in turn 1A5Q1 and 1A5Q2 start to oscillate. The amplitude of the oscillations is adjusted by 1A4R21. (When 1A4R21 is adjusted, the base voltage of 1A4Q3 varies and this in turn varies the base current of 1A5Q1 and 1A5Q2 and hence the amplitude of the oscillations.) Voltage reference for pin 2 is derived from the fixed voltage regulator 1A4U2. Constant voltage is maintained at pin 6 and hence that of the oscillations amplitude by 1A4U3 which senses any variation of the difference in voltages between pins 2 and 3. Pin 2 is fixed by the resistor network 1A4R19, 1A4R21, and 1A4R22 and at pin 3 voltage is derived by feedback network 1A4R18 and 1A5R7. If there is any variation at pin 3 due to load or line voltages, the regulator will correct all changes through its feed back loop and maintain a constant amplitude of oscillation. 1A4CR1 is added for the protection of 1A4Q2 and diodes 1A5CR1 to 1A5CR4 are added for the protection of 1A5Q1 and 1A5Q2.

c. High Voltage – High Frequency AC Voltage. output of the basic oscillator (low voltage, high frequency) is stepped up through transformer 1A5T2 to suitable values.

d. Beam Power Supply. High voltage fast switching rectifier diodes 1A5CR9 to 1A5CR12 rectify the high voltage ac appearing across pins 8 and 10 of transformer 1A5T2. After suitable filtering, it is applied to the klystron cathode (-1250V).

e. The Repeller Voltage. AC voltage appearing across pins 4 and 7 of the transformer is rectified by diodes 1A5CR5 to 1A5CR8 and applied to the voltage regulator network 1A3CR8, 1A3CR9 to 1A3CR12, 1A3Q2 and 1A3Q3. 1A3CR8, 1A3CR9 to 1A3CR12 are zener diode which establish a reference voltage for the regulator 1A3Q2 and 1A3Q3 are used in a Darlington arrangement to provide the necessary regulation. The ground repeller supply is referenced to the -1250V beam supply.

f. +40V Supply for Control Circuits (Fig. 5-7). The bridge rectifier 1A5BR1 rectifies the ac voltage across pins 11 and 12 of transformer 1A5T2. This +40V is applied to the operational amplifier 1A5U1 whose output floats at -1250V. The output of the operational amplifier is connected to the inverting input (pin 2) of the operational amplifier and the non-inverting input is floating and can be varied from 0 to 32 volts (32 volts appearing across zener diode 1A5CR15) by resistor 1A5R5 and thus the entire +40V supply floats at -1250V.

3-17 KLYSTRON FILAMENT SUPPLY (Fig. 5-2 and 5-2.1)

The klystron filament is supplied with regulated dc voltage to minimize drift and incidental amplitude and frequency modulation. The klystron filament supply consists of bridge rectifier 1A3BR1 and voltage regulator 1A3U1. It is referenced to the -1250V beam supply. The filament voltage is adjusted to 6.3V by potentiometer 1A3R1.

3-18. POWER SUPPLY ADJUSTMENTS

The power supplies are provided with three adjustments which are described below:

a. -1250 ADJ CONTROL (Fig. 4-11). The -1250 ADJ control 1A4R21 sets the operating point for control amplifier 1A4U3 which maintains the beam power supply at its set value.

b. -1850 ADJ CONTROL. The -1850 ADJ control 1A3R2 sets the operating point for regulator 1A3Q2 and 1A3Q3 which maintains the repeller power supply at its set value.

c. BEAM CURRENT ADJ Control (Fig. 4-6). The BEAM CURRENT ADJ control 1A5R5, which has a range of approximately 32 volts, adjusts the beam current through the klystron. The beam current is measured by monitoring the voltage across 1A5R8 which appears between 1A4TP2 and 1A4TP4.

3-19. 400 TO 60 Hz CONVERTER 1A10 (See Fig. 5-5) (Serial No. 2-60A Thru 2-117A Only)









The 115V, 400 Hz power source is applied to terminals 1A10E1 and 1A10E2. 1A10BR1 and 1A10C1 constitute the full-wave rectifier. The output of that circuit is dropped down by 1A10R13 to 12 volts and then supplies the three Integrated circuits 1A10U1, 1A10U2, and 1A10U3. 1A10U3 is an operational amplifier and is configured as a 480 Hz square wave generator. 1A10U2 is a five stage counter configured for divide-by-eight operation. The outputs from 1A10U1, pins 10 and 11 are, accordingly, 60 Hz overlapping, 25% duty cycle waveforms. These outputs then drive switching circuit (1A10Q1, 1A10Q4, and 1A10Q6) and switching circuit (1A10Q2, 1A10Q3, and 1A10Q5). Thus, the voltage across the fan consists of rectangular pulses of alternating polarity. 1A10CR2 and 1A10CR3 conduct briefly after the switching circuit (1A10Q1, 1A10Q4 and 1A10Q6) turn-off and allows the fan current to decrease to zero. 1A10CR1 and 1A10CR4 exhibit similar action in conjunction with switching circuit (1A10Q2, 1A10Q3, and 1A10Q5).

3-20. MODULATOR MD-1075/URM (See Fig. 5-6)

The MD-1075/URM Modulator is a solid-state function generator which provides fast rectangular pulses, square waves and sawtooth waveforms for the generator.



3-21 BLOCK DIAGRAM ANALYSIS MD-1075/URM (Fig. 3-3)

The MD-1075/URM is comprised of a group of circuits which generate, shape and delay the various waveforms as required. The rate generator is a free-running unijunction oscillator which serves to generate the basic pulse repetition rates. This circuit is also the source of the sawtooth for FM operation. When the FUNCTION switch, 2S2, is set at its INT position and the SELECTOR switch, 2S3, is set at its INT position, the pulse output of the rate generator, divided by two by means of the $\div 2$ Flip/Flop, is applied to the Schmitt trigger. The Schmitt trigger output, a square wave, is applied to the pulse generator where the output pulses of desired width and delay are generated. The pulse generator consists of two integrated circuit monostable multivibrators 2IC1 and 2IC2. 2IC1 develops the desired pulse delay of 2 to 2000 μ sec in conjunction with front panel controls SYNC DELAY μ SEC, 2R41, and LOW-X1-X10-X100 multiplier switch, 2S4, 2IC1 has two outputs; one output is applied to the undelayed sync amp for amplitude and impedance conditioning prior to

appearing at the UNDELAYED SYNC OUT output connector 2J3. The other output is applied to 2IC2 where the desired output pulse width of 0.2 to 2000 μ sec is developed in conjunction with PULSE WIDTH control, 2R76 and X1-X10-X200-X1000 switch, 2S7. 2IC2 also has two outputs; one output is applied to the delayed sync amp for amplitude and impedance conditioning prior to appearing at the DELAYED SYNC OUT connector 2J2. The other output is routed through the FUNCTION switch 2S2F to the  output amplifier prior to appearing at the  OUT output connector 2J5. With the FUNCTION switch set at its EXT  /INT  position and the SELECTOR switch set at INT, the square wave output of the Schmitt trigger is applied to the  output amplifier and the resultant output at the  OUT output connector is a square wave. With the FUNCTION switch set at its EXT  /INT  position and the SELECTOR switch set at its EXT(-) or EXT(+) position, an external signal connected to the EXT INPUT connector, 2J1, is processed through the external signal amplifier to the Schmitt trigger. The output signals appearing at the  OUT, UNDELAYED SYNC OUT, and DELAYED SYNC OUT connectors 2J5, 2J3, and 2J2 respectively are directly related to the external input signal applied to the EXT INPUT connector 2J1. With the FUNCTION switch set at its FM position and the SELECTOR switch set at INT, the sawtooth output of the rate generator is processed through the sawtooth amplifier. The output of the sawtooth amplifier is applied across FM AMPLITUDE control 2R21. The wiper of the FM AMPLITUDE control is the output sawtooth and is connected to the FM OUT output connector, 2J4. With the FUNCTION switch set at FM and the SELECTOR switch set at EXT(+), the rate of the rate generator will be synchronized with the rate of the externally applied synchronizing signal provided that the RATE control and X1, X10, X100 switches are set to a rate lower than the incoming synchronizing rate.

3-22. MODULATOR MD-1075/URM CIRCUIT ANALYSIS (Fig. 3-3 and 5-6)

Paragraphs a. through j. contain a detailed analysis of the various circuits of the Modulator MD-1075/URM.

a. Rate Generator 2Q1, 2Q23. The rate generator is a free-running unijunction oscillator. With the FUNCTION switch in its INT or EXT  /INT  position and the RATE X1-X10-X100 switch set at its X100 position the basic repetition rate is determined by RC components 2R4, 2R5, 2R6, and 2C3 and will be in the range of 2,000

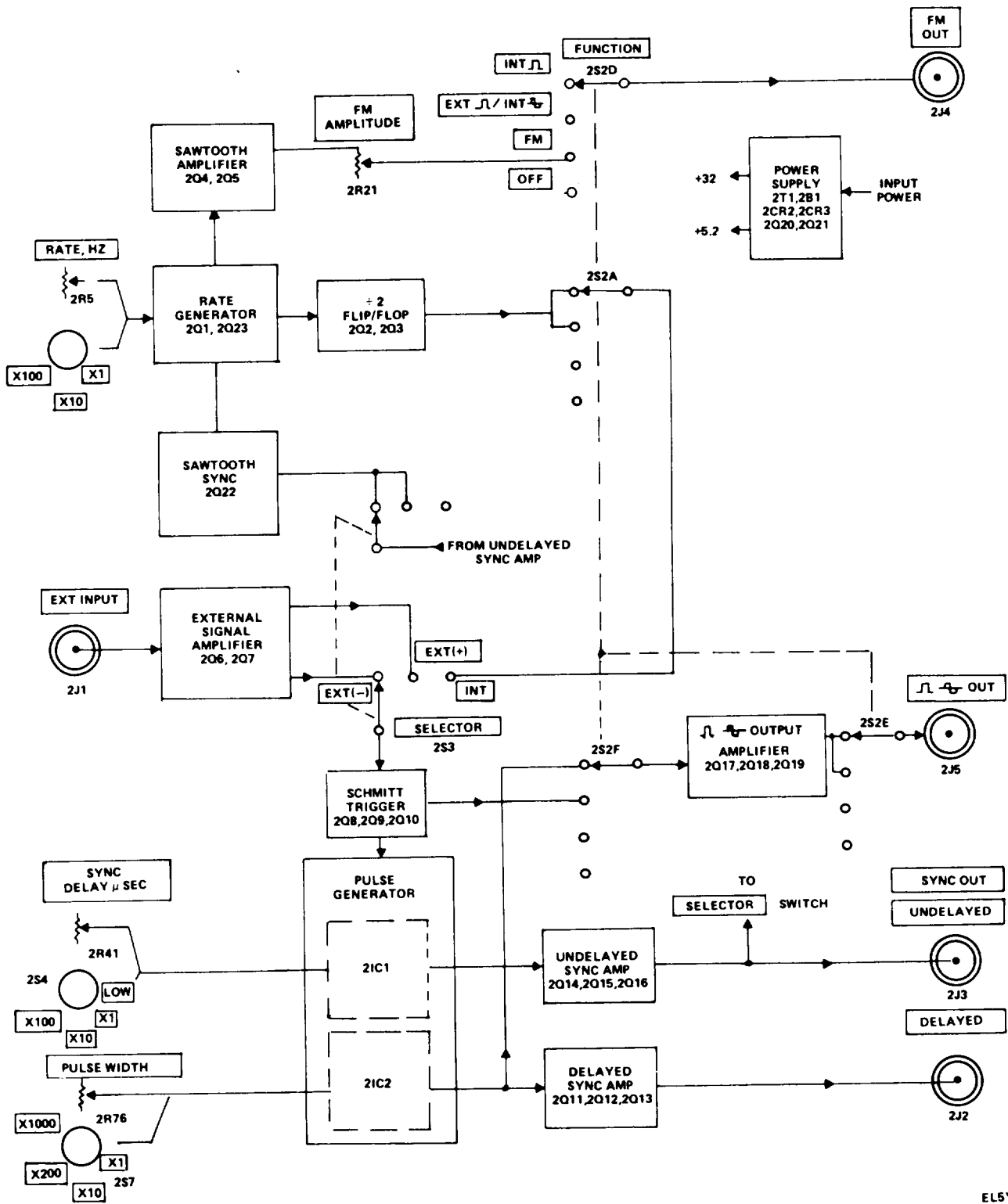



EL5YQ-8

Figure 3-3. .MD-1075/URM Modulator, Block Diagram

to 20,000 pps. The actual rate will depend upon the setting of front panel RATE control R5. When the RATE X1-X10-X100 switch is placed in its X1 position the repetition rate will be in the range of 20-200 pps due to the addition of 2C1 which increases the charging time constant in the unijunction emitter circuit. 2Q23 is a feedback current source which linearizes the sweep. As the capacitive components charge in the emitter circuit a positive going sawtooth waveform is developed. When the firing potential is reached at the emitter, 2Q1 turns on and allows the capacitive components to discharge through 2R2 and 2L1 creating sharp positive pulses across 2R2 and 2L1. These pulses are fed to the ÷ 2 Flip/Flop which divides the input pulses in half to develop the output repetition rates of 10 to 10,000 pps. When the FUNCTION switch is placed in its FM position additional capacitive components are added to the emitter charging circuit. The components are 2C7, 2C8, and 2C9, in the RATE X1-X10-X100 positions respectively. No division takes place in this mode of operation and the rates developed are the output rates. The sawtooth waveform developed in the 2Q1 emitter circuit is fed to the sawtooth amplifier for further processing. 2R6 in the 2Q1 emitter circuit is adjusted in conjunction with 2R5 to provide the high repetition rate which is approximately 10,000 pps. When the selector switch is placed in the external positions, an external positive signal (selector set to EXT(+)), an external negative signal (selector set to EXT(-)), or a sinewave may be used to synchronize the sawtooth waveform. This is performed by transistor 2Q22. 2Q22 is turned on by the undelayed signal pulse. This causes the unijunction transistor 2Q1 to fire.

b. ÷ 2 Flip/Flop 2Q2, 2Q3. The ÷ 2 Flip/Flop accepts the positive going pulses from the rate generator, in the range of 20-20,000 pps, and produces a square wave at the collector of 2Q3, at the output rate of 10-10,000 Hz. The square wave is routed through the FUNCTION switch to the INT position of the SELECTOR switch 2S3. When the SELECTOR switch is in the INT position the square wave is fed to the Schmitt trigger circuit for further processing.

c. Schmitt Trigger 2Q8, 2Q9, 2Q10. The input to the Schmitt trigger is determined by the position of the SELECTOR switch. When the SELECTOR switch is in its INT position, a square wave from the ÷ 2 Flip/Flop is applied to the input. When the SELECTOR switch is in its EXT - or EXT + position the output of the ext sig amplifier will be applied to the input. The output waveform of the ext sig amplifier will depend upon the type of signal waveform connected to the EXT SYNC connector



2J1. The Schmitt trigger circuit composed of 2Q8 and 2Q9 is a dc coupled amplifier used to improve the rise and fall time of the input waveform. 2Q10 is an emitter follower used to provide a low output impedance for the circuit. A positive going signal will provide a positive going signal at the emitter of 2Q9. The Schmitt trigger provides two outputs; a square wave which is direct coupled through the FUNCTION switch, when it is in its EXT /INT  position, to the  output amplifier. The other output is differentiated by 2C16 and 2R38 and routed to the pulse generator for pulse shaping and delay.

d. Pulse Generator 2IC1, 2IC2. The pulse generator consists of two integrated monostable multivibrators 2IC1 and 2IC2. As the integrated circuits are connected, they require a positive going signal to activate the output. The positive going output of the Schmitt trigger used to initiate pulse generation is differentiated by 2C16 and 2R38 and applied to the input of 2IC1. The pulse output of 2IC1 is a negative going waveform whose duration is determined by 2C17, 2C18, 2C38 or 2C39, 2C40 and the front panel SYNC DELAY controls 2R41 and 2S4. The output pulse of 2IC1 is differentiated by 2C19 and 2R42, the leading or negative going edge is routed to the undelayed sync amp while the positive going edge, which represents the fall of the pulse developed by 2IC1, is connected to the input of 2IC2. The positive input to 2IC2 initiates pulse generation by 2IC2 which is a positive going waveform whose duration is the output pulse width determined by 2C36, 2C37, 2C48 or 2C49/C50 and PULSE WIDTH, 2R76 and 2S7. The duration of the pulse generated by 2IC1 therefore represents the delay time between the undelayed sync pulse and the output delayed sync pulse. The leading edge of the output pulse and the delayed sync pulse are coincident.

e. Undelayed Sync Amp 2Q14, 2Q15, 2Q16. The undelayed sync amplifier input transistor 2Q14, a npn type, is quiescently cut off. The negative going pulse from the differentiating network of 2C19 and 2R42 causes 2Q14 to conduct allowing the collector to go positive causing 2Q15 to conduct dropping its collector to ground potential. When the collector of 2Q15 assumes its low potential state 2Q16 conducts allowing its collector to go positive and somewhat less than +32 volts. The collector of 2Q16 is connected to the UNDELAYED SYNC OUT connector 2J3 through 2R73.

f. Delayed Sync Amp 2Q11, 2Q12, 2Q13. The delayed sync amplifier input transistor 2Q11, an npn type, is quiescently cut off. The positive going pulse from the differentiating network of 2C25 and 2R57 causes 2Q11 to conduct

and develop a positive going signal across 2R58. The positive potential applied to 2Q12, which is also quiescently cut off causes 2Q12 to conduct dropping its collector to ground potential. When the collector of 2Q12 assumes its low potential state 2Q13 conducts allowing its collector to go positive and somewhat less than +32 volts. The collector of 2Q13 is connected to the DELAYED SYNC OUT connector 2J2 through 2R62.

g.  Output Amplifier 2Q17, 2Q18, 2Q19. The  output amplifier input transistor, 2Q17, is quiescently cut off and is caused to conduct by applying positive going waveforms to its base. 2Q18, a pnp type, and 2Q19, an npn type, act in a complementary fashion. When 2Q17 is in cutoff 2Q18 is also cut off and 2Q19 is conducting maintaining the output seen at OUT output connector 2J5 at ground potential. When 2Q17 conducts it causes 2Q18 to conduct and 2Q19 to be cut off allowing the output to rise to a positive level somewhat less than +32 volts.

h. Ext Input Amplifier 2Q6, 2Q7. The external input applied to the ext input amplifier is applied to the EXT INPUT connector 2J1. The input signal is coupled through the network of 2R22 and 2C12 and applied to the gate of 2Q6. The signal appearing at the gate of 2Q6 may be positive or negative and is held to a potential of approximately 2.4 volts due to the clamping action of diodes 2CR5 through 2C12. The drain of 2Q6 is coupled to paraphrase amplifier 2Q7 which will provide two signals of opposing phase to the front panel SELECTOR switch 2S3.

i. Sawtooth Amplifier 2Q4, 2Q5. The input to the sawtooth amplifier is a positive going sawtooth waveform developed across the capacitors in the emitter circuit of the rate generator. 2Q4 is an emitter follower applying a positive going sawtooth waveform to 2Q5. The positive going waveform causes 2Q5 to conduct developing a negative going sawtooth which is applied across front panel FM DEV AMPLITUDE control 2R21. The wiper arm of 2R21 routes the output sawtooth waveform through the FUNCTION switch to the FM OUT connector 2J4. The emitter resistor of 2Q4 is a potentiometer and is adjusted to achieve a proper base level for the output sawtooth.

j. Power Supply. The power supply develops two regulated dc voltages; +32 volts and +5.2 volts. The input power is routed through cable W1, power switch 2S6, fuse 2F1, voltage selector switch 2S5 to transformer 2T1. 2T1 steps the input voltage down to the required level which is then full-wave rectified by bridge 2B1. The output of 2B1 is applied to the collector of 2Q20, the +32 volt output transistor. The base of 2Q20 is held at +33 volts by zener diode 2CR2. The +32 volt output appears at the emitter of 2Q20 and is distributed throughout the modulator circuitry. The +32 volt output is also applied to the collector of 2Q21, the +5.2 volt output transistor. The base of 2Q21 is held at +6 volts by zener diode 2CR3. The +5.2 volt output appears at the emitter of 2Q21 and is used primarily in the pulse generator circuitry which utilizes integrated circuits.

CHAPTER 4

MAINTENANCE

4-1. GENERAL

This chapter contains maintenance and service instruction including recommended test equipment, preventive maintenance, minimum performance tests, troubleshooting and assembly and disassembly procedures.

4-2. TEST EQUIPMENT REQUIRED

The test equipment required for the maintenance of Signal Generator AN/URM-206 is listed in Table 4-1.

4-3. PREVENTIVE MAINTENANCE

Perform a preliminary visual and manual inspection of the signal generator before undertaking any maintenance procedure. Remove the top and bottom dust covers of the signal generator to inspect its interior. Look for loose or damaged parts, dust, dirt, oil or grease, and corrosion. Correct such conditions before proceeding with maintenance.

WARNING

THE STABILIZER INPUT TERMINAL BOARD, ON THE REAR PANEL, HAS A REGULATED POTENTIAL OF 1850 VOLTS DC ON ITS TERMINALS. SEVERE SHOCK OR DEATH MAY RESULT FROM ACCIDENTAL CONTACT WITH THESE TERMINALS. THE TERMINALS ARE COVERED TO PREVENT ACCIDENTAL CONTACT. THE COVER SHOULD NOT BE REMOVED UNLESS AN EXTERNAL LOCK BOX IS TO BE CONNECTED.

CAUTION

DO NOT DISTURB ANY ADJUSTMENTS ON COMPONENTS OF THE KLYSTRON OSCILLATOR CASTING. A COMPLETE REALIGNMENT MAY BE REQUIRED IF ANY ADJUSTMENTS ARE TOUCHED.

Table 4-1.1 contains the criteria for periodic inspection of the signal generator. A regular schedule should be adhered to so that minor faults can be caught and corrected before more serious damage occurs.

4-4. MINIMUM PERFORMANCE TESTS

The minimum performance tests, detailed in paragraphs a. through k. will determine whether the signal generator is operating within the specifications listed in Table 1-2.

a. Electrical Power Input, Switch Selection and Turn-On Procedure. The signal generator is shipped ready for operation, with the 115/230 V switches of SG-1145/URM and MD-1075/URM for 115 vac. When the signal generator is operated from a 230 V supply set the 115/230 V switches to 230 V and replace the fuse in the SG-1145/URM with the 1.5 amp fuse and the fuse in MD-1075/URM with the 1/8 amp fuse. The FREQ SET 50/60, 400 Hz switch is set to 50/60 Hz. When the line frequency is 400 Hz, set the FREQ SET 50/60, 400 Hz switch to 400 Hz. Connect power cable B160826 to the AC OUTPUT connector of MD-1075/URM and AC INPUT connector of SG-1145/ URM. Connect power cable 6160833 to the AC INPUT connector of MD-1075/URM and the external ac power source. Set the POWER switches on SG-1145/URM and MD-1075/URM to their ON positions. Allow a 20-minute warm-up period before attempting any of the minimum performance tests. At the end of each test, disconnect the equipment.

b. Output Frequency Range and Accuracy Test.

- (1) Set the FREQUENCY GHz control to 7.00 GHz.
- (2) Set MODULATION SELECTOR switch to CW.
- (3) Set ΔF control to central "0" position.
- (4) Adjust POWER SET control for CAL on the power monitor meter.
- (5) Set ATTENUATOR control to read 0 dBm output on the attenuator dial.

TABLE 4-1. LIST OF TEST EQUIPMENT

Equipment	Nomenclature	NSN
Counter, Electronic, Digital Readout	AN/USM-459 (HP 5328A/E42)	6625-01-061-8928
Oscilloscope	AN/USM-281 C	6625-00-106-9632
Multimeter	Triplet 630A	6625-00-553-0251
Wavemeter	ME-495	6625-00-930-9687
Power Meter	H-P 435A	6625-00-449-9167
Power Sensor	H-P 8481A	6625-00-354-9762
Spectrum Analyzer	H-P 8555A P/O HP 141T (IP1216)	6625-00-424-4370
Attenuator Pad	HF A50ATT3DB	
Detector	H-P 423B	
AC Power Source	Elgar Model 501A	
Pulse Generator	H-P 214A	
Differential Voltmeter w/Volt Box	Fluke Model 801 Fluke model 605B	

(6) Connect Counter, Electronic, Digital Readout, AN/USM-459 to RF OUTPUT connector on SG-1145/URM.

(7) Record Counter, Electronic, Digital Readout, AN/USM-459 reading. Accuracy should be within $\pm 1\%$ of dial reading.

(8) Perform steps (1) through (7) at the following FREQUENCY GHz control settings:

7.50	9.50
8.00	10.00
8.50	10.50
9.00	11.00

c. Output Power and Level Accuracy Test.

(1) Set the FREQUENCY GHz control to 7.0 GHz.

(2) Set the MODULATION SELECTOR switch to CW.

(3) Set the ΔF control to 0.

(4) Adjust the POWER SET control for a reading of CAL in the power monitor meter.

(5) Set the ATTENUATOR control for a reading of 0 dBm output on the attenuator dial. (This is done by rotating the attenuator dial via the ATTENUATOR control until the 0 dBm line on the attenuator dial is lined with the POWER SET hairline.)

(6) Set the MODULATION SELECTOR switch to RF OFF.

(7) Connect Power Meter H-P 435A and Power Sensor H-P 8481A to the RF OUTPUT connector of the signal generator and zero set on +5 dBm range.

(8) Set the MODULATION SELECTOR switch to CW.

TABLE 4-1.1. PERIODIC INSPECTION

Item	Inspect For	Inspection Interval
Case and panel	Dirt or corrosion; dents, cracks, scratches, or other physical damage; loose or missing hardware.	Monthly
Switches and potentiometers	Loose or missing knobs; defective switch action; loose mounting; bent, broken or loose terminals; proper detent or snap action; smooth potentiometer rotation from stop to stop; cracked, damaged.	Weekly
Connectors	Bent, broken, or corroded pins; damaged threads; cracked shell; loose or missing hardware.	Monthly
Panel lamps	Cracked or broken lens; missing or defective lamps; loose or missing hardware; bent, broken or corroded terminals.	Weekly
Wiring	Frayed, broken, or abraded insulation; loose connections; broken wires.	Monthly
Electrical parts	Loose connections or mounting; evidence of overheating such as being cracked, broken, blistered or charred.	Monthly
Cables	Frayed, broken, kinked, or abraded insulation; loose or missing clamps; broken wires; damaged connectors.	Weekly
Fuses	Cracked, damaged, or corroded fuse holders and fuses; correct current rating of fuses; fuse holders securely mounted.	Monthly

- (9) Power level should read 0 dBm ±3.0 dB adjusting the power meter range accordingly.
- (10) Repeat steps (1) through (9) at -10 dBm and -20 dBm. Power level should read ±2.0 dB.
- (11) Repeat steps (1) through (9) for 11.0 GHz.

NOTE

The attenuator is extremely accurate so that if the output accuracy at 0 dBm, -10 dBm, and -20 dBm are all within the specified limits, all other values below -20 dBm will be correct.

d. Internal Square Wave Modulation Test.

- (1) Connect equipment as shown in Fig. 4-1.
- (2) Set FREQUENCY GHz to 7.0 GHz.
- (3) Set the MODULATION SELECTOR switch to CW and the ΔF control to 0. Adjust the POWER SET control for an indication of CAL on the power monitor meter.
- (4) Adjust the ATTENUATOR control for a reading of 0 dBm on the attenuator dial.
- (5) Set the MODULATION SELECTOR switch to EXT .

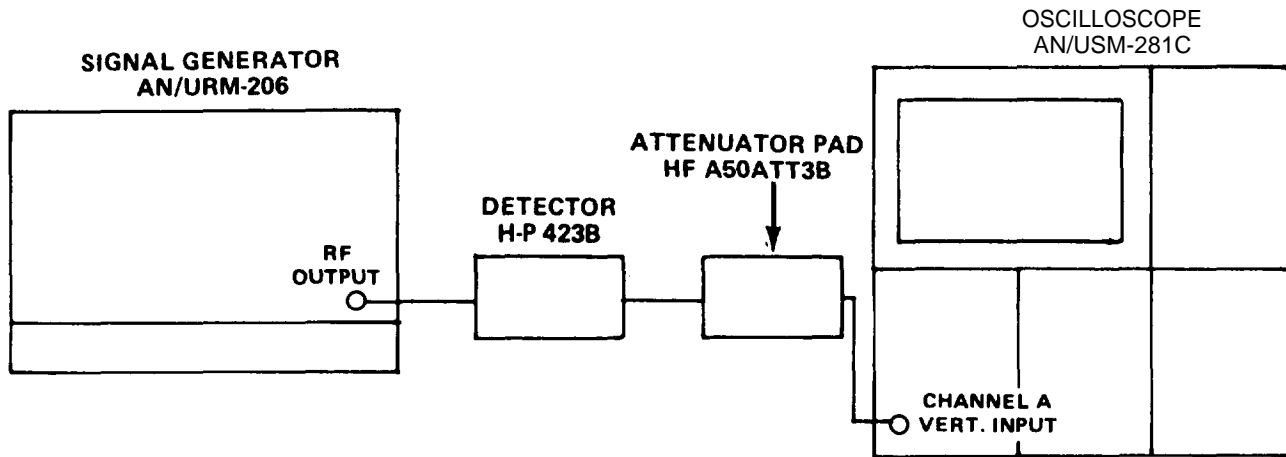

EL5YQ-9

Figure 4-1. Modulation Characteristics Test Set-Up

(6) Set the MD-1075/URM controls as follows:

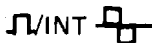
Control	Position
FUNCTION	EXT 
RATE	X1
SELECTOR	INT
RATE Vernier	Fully clockwise

(7) Set the oscilloscope for a square wave display.

(8) Slowly rotate the RATE control vernier counterclockwise and observe the display on the oscilloscope. The square wave rate should decrease smoothly below 40 Hz to a minimum of typically 10 Hz.

(9) Set the RATE multiplier control to X100.

(10) Slowly rotate the RATE control vernier of the modulator clockwise. The display should increase smoothly beyond a rate of 4000 Hz.

(11) Repeat steps (1) through (10) at 9.0 and 11.0 GHz.

e. Internal Pulse Modulation Test.

(1) Connect test equipment as shown in figure 4-1.

(2) Perform steps (2) through (5) of paragraph 4-4 b.

(3) Set FUNCTION switch of the modulator to INT  and the SELECTOR switch to INT.

(4) Set MODULATION SELECTOR switch to EXT .

(5) Set SYNC DELAY multiplier to LOW and SYNC DELAY vernier control fully counterclockwise.

(6) Set RATE control fully clockwise and the RATE multiplier to X1.

(7) Set PULSE WIDTH multiplier switch to X10 and set the PULSE WIDTH vernier control fully counterclockwise. Set oscilloscope for stable display of the pulsed signal.

(8) Rotate the RATE control vernier slowly counterclockwise and observe the display on the oscilloscope. The pulse repetition rate should decrease smoothly below 40 Hz to a minimum of typically 10 Hz.

- (9) Set the RATE multiplier to X100.
- (10) Rotate the RATE control vernier slowly clockwise. The display should increase smoothly beyond a rate of 4000 Hz to typically 10 kHz.
- (11) Set the PULSE WIDTH vernier control fully counterclockwise and multiplier switch to X10.
- (12) Set the RATE control vernier fully counterclockwise and multiplier switch to X100.
- (13) Rotate the PULSE WIDTH control slowly clockwise and observe that pulse display on the oscilloscope increases smoothly until it goes beyond 10 microseconds to a maximum of typically 20 microseconds.
- (14) Set the PULSE WIDTH multiplier switch to X1.

- (15) Observing pulse width on the oscilloscope, rotate the PULSE WIDTH vernier counterclockwise until the pulse width on oscilloscope decreases through 0.5 microseconds to a minimum of typically 0.2 microseconds.
- (16) Set the PULSE WIDTH vernier control for a pulse width of 1 microsecond as observed on the oscilloscope. The rise and fall times should be <0.2 microseconds.

f. External Pulse Modulation Test.

- (1) Connect equipment as shown in figure 4-2.
- (2) Set FREQUENCY GHz dial to 9.0 GHz.
- (3) CAL signal generator on CW for 0 dBm output. (See paragraph 2-5.)

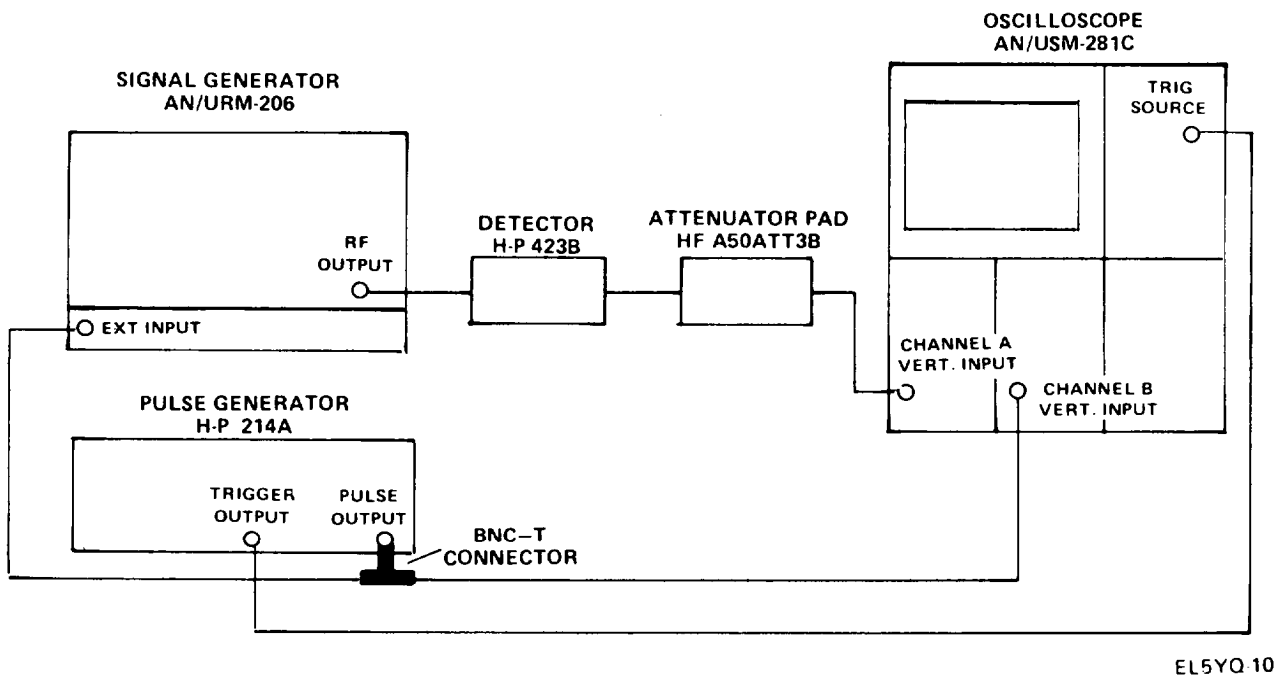



Figure 4-2. External Pulse Modulation Test Set-Up

(4) Set the MODULATION SELECTOR switch to EXT  position.

(5) Set Modulator MD-1075/URM controls as follows:

<u>Control</u>	<u>Position</u>
FUNCTION	EXT  /INT 
SELECTOR	EXT (+)

(6) Set oscilloscope for dual trace observing input video and output detected pulse signals. The input pulse will range from below 20 to above 70 volts and the output pulse will be approximately 50 millivolts, depending on the sensitivity of the detector used. Check that the rise and fall time of the input pulse is less than 0.2 microseconds.

(7) Set the HP 214A pulse generator PULSE WIDTH control to 0.5 microseconds and INT. REP. RATE to 100 kHz.

(8) Observe that output pulse is steady as pulse generator AMPLITUDE control is varied from 20 to 70 volts peak.

(9) Set Pulse Generator HP 214A for 70 volts, 10 Hz.

(10) Observe oscilloscope display for a steady output pulse as the pulse generator width is varied from 0.5 to 2500 microseconds.

(11) Repeat steps (2) through (10) except that the positive amplitude output of the Pulse Generator HP 214A is changed to the negative polarity and the SELECTOR switch of Modulator MD-1075/URM is switched to EXT(-).

g. Internal Frequency Modulation Test.

(1) Set FREQUENCY GHz control to 11.0.

(2) Set ΔF control to 0.

(3) Set MODULATION SELECTOR switch to CW.

(4) Adjust POWER SET control for CAL on the power monitor meter.

(5) Set ATTENUATOR control to read 0 dBm output on the attenuator dial.

(6) Connect equipment as shown in Fig. 4-3.

(7) Adjust the controls on spectrum analyzer to locate the 11.0 GHz signal and display it in the center of the CRT screen.

(8) Set the MODULATION SELECTOR switch to EXT FM.

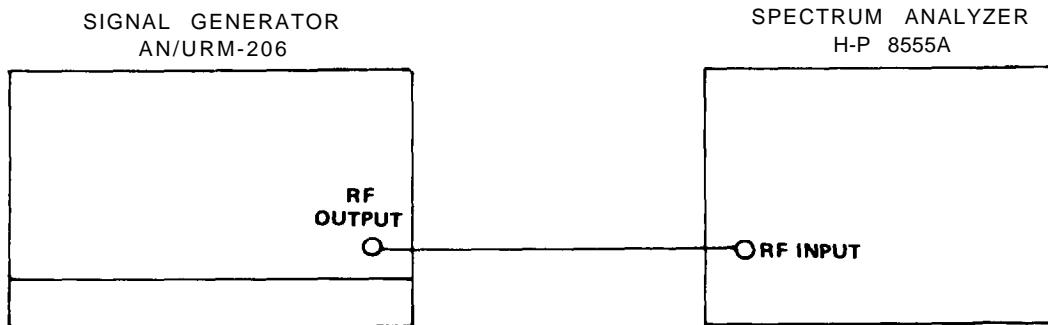

EL5YQ-11

Figure 4-3. Internal Frequency Modulator Test Set-Up

(9) Set the controls on Modulator MD-1075/URM as follows:

Control	Position
FUNCTION switch	FM
SELECTOR switch	INT
RATE switch	X100
RATE Vernier	APPROX. MIDDLE

(10) Rotate the FM DEV AMPLITUDE control clockwise until an FM deviation of 5 MHz nominal is indicated on the analyzer.

(11) Rotate the RATE vernier slowly counterclockwise and observe that 5 MHz FM deviation is still indicated on the analyzer.

(12) Switch the RATE switch to X1 and set the RATE vernier approximately in the middle. Observe that 5 MHz deviation is still indicated on the analyzer.

(13) Repeat steps (1) through (12) at 7.0, 8.0, 9.0 and 10.0 GHz.

h. Internal Synchronization Test.

(1) Connect equipment as shown in Fig. 4-4.

(2) Set FUNCTION switch to INT .

(3) Set SELECTOR switch to INT.

(4) Measure the amplitude, polarity, and pulse width. The synchronizing signal should be of positive polarity between 25 to 100 volts in amplitude with a maximum pulse width of 5 microseconds.

i. External Synchronization Sine Wave Test.

(1) Connect equipment as shown in Fig. 4-5.

(2) Set FREQUENCY GHz control to 9.00 GHz.

(3) Set MODULATION SELECTOR switch to CW and adjust the POWER SET control for an indication of CAL on the power level monitor meter.

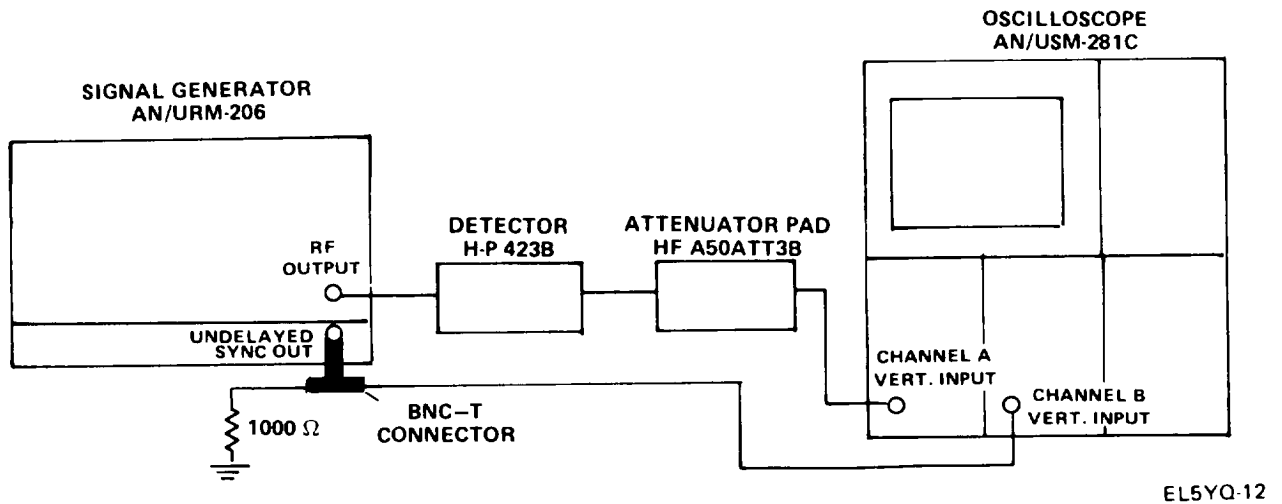
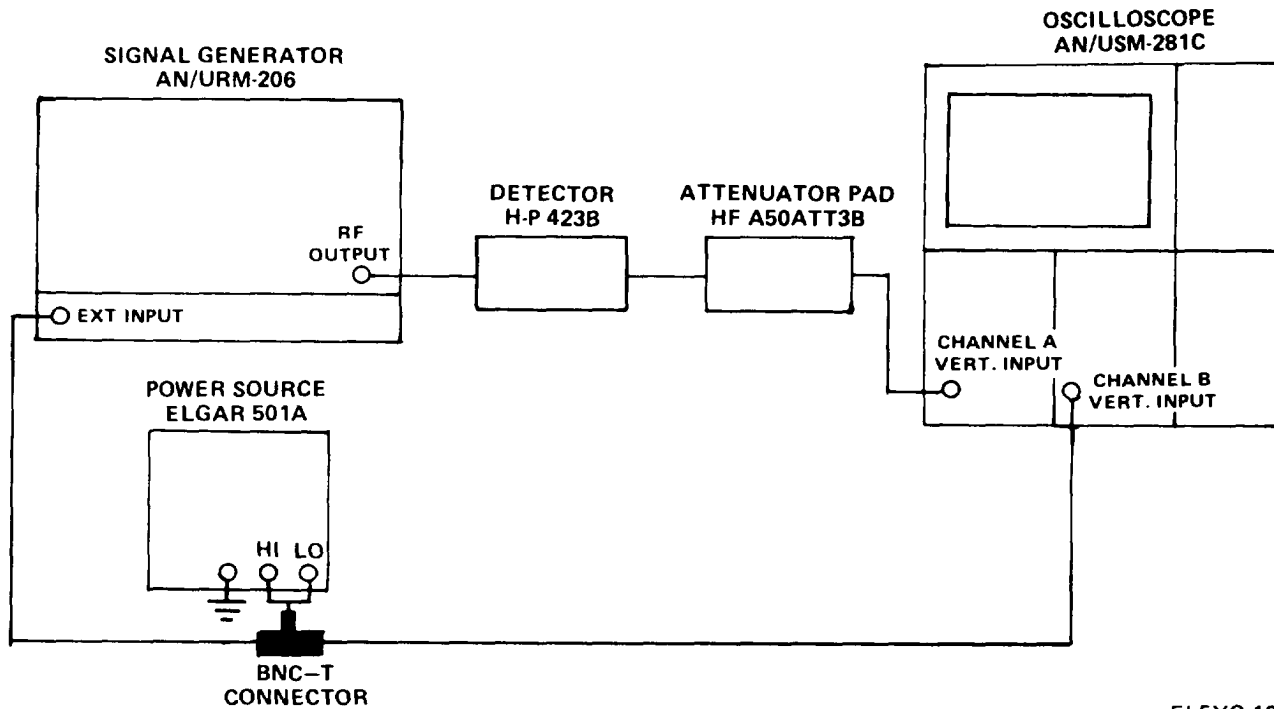

Figure 4-4. Internal Synchronization Test Set-Up



EL5YQ-13

Figure 4-5. External Synchronization Sine Wave Test Set-Up

(4) Adjust ATTENUATOR control for 0 dBm RF output power and set MODULATION SELECTOR to EXT .

(5) Set controls on MD-1075/URM as follows:

Control	Position
FUNCTION	INT
SELECTOR	EXT (+)
PULSE WIDTH Multiplier	X10
PULSE WIDTH Vernier	Fully Clockwise

(6) Set AMPLITUDE control of ELGAR 501A to 5 volts rms (14 volts peak to peak) at 40 Hz by monitoring Channel B of Oscilloscope AN/USM-281C.

(7) Set oscilloscope for stable display of RF detected pulses (Channel A), and external synchronizing signal (Channel B) simultaneously.

(8) Check that the RF detected pulses in Channel A are synchronized and stable as the frequency range of the oscillator is varied from 40 Hz to 4000 Hz.

(9) Repeat steps (6) through (9) for ELGAR 501A AMPLITUDE control set to 50 volts rms.

j. External Synchronization Pulse Test.

(1) Set up equipment as shown in Fig. 4-2.

(2) Set FREQUENCY GHz control to 9.00 GHz.

(3) Set MODULATION SELECTOR switch to CW and adjust the POWER SET control for an indication of CAL on the power level monitor meter.

(4) Adjust ATTENUATOR control for 0 dBm RF power output and set MODULATION SELECTOR switch to EXT .

(5) Set controls on MD-1075/URM as follows:

<u>Control</u>	<u>Position</u>
FUNCTION	INT 
SELECTOR	EXT (+)
PULSE WIDTH Multiplier	X1
PULSE WIDTH Vernier	Fully Clockwise

(6) Set Pulse Generator HP 214A PULSE OUTPUT for the following settings as measured on Channel B of Oscilloscope AN/USM-281C:

Pulse Rate	4000Hz
Pulse Width	5 microseconds
Amplitude	5 volts, positive

(7) Set oscilloscope for stable display of RF detected pulses (Channel A), and external synchronizing signal (Channel B) simultaneously.

(8) Check that RF detected pulses in Channel A are stable and synchronized with the pulses in Channel B as the pulse rate is reduced from 4000 Hz to 40 Hz.

(9) Repeat steps (6) through (8) for Pulse Generator PULSE OUTPUT for the following settings:

(a) Pulse width	0.5 microsecond
Amplitude	5 volts, positive

(b) Pulse Width	5 microseconds
Amplitude	50 volts, positive

(c) Pulse Width	0.5 microsecond
Amplitude	50 volts, positive

(10) Repeat steps (6) through (9) except set PULSE OUTPUT polarity to (-) in step (6) and SELECTOR switch to EXT(-) in step (5).

k. Output Impedance Test.

(1) Set the MODULATION SELECTOR switch to RF OFF.

(2) Set Multimeter Triplet Model 630A on the ohms X10 scale and measure the resistance between ground and the center conductor of the RF OUTPUT connector. The impedance should be 50 ohms, nominal.

4-5. TROUBLESHOOTING

The troubleshooting procedure for the signal generator is given in Table 4-2. If the location of the trouble is indefinite or cannot be localized, start the troubleshooting procedure at the step that most closely resembles the trouble encountered. Component locations are shown in Figures 4-6 through 4-16.

WARNING

A REGULATED DC VOLTAGE OF 1850 VOLTS WILL BE ENCOUNTERED DURING THE TROUBLESHOOTING TESTS. DO NOT CONNECT OR DISCONNECT TEST EQUIPMENT WHICH CONNECTS INTERNALLY WITH THE INSTRUMENT ENERGIZED.

TABLE 4-2. TROUBLESHOOTING CHART

Step	Symptom	Probable Cause	Corrective Action
1	Power indicator lights do not glow. (Model SG-1145/URM and MD-1075/URM)	<ul style="list-style-type: none"> a. Defective power cable B160833 b. Defective power jumper cord B160826 c. Faulty fuse 1A1F1. d. VOLT SET switch 1A1S1 in wrong position. e. Defective POWER switch 1A1S1. f. 300 vac not present between pins 2 and 4 of connector 1A3J2. Transformer 1A2T1 defective. g. Defective lamp 1DS1. h. Open resistor 1A3A1R18. i. Broken wires on Pushbutton Board 1A3. j. Defective lamp 2DS1 k. SELECTOR switch 2S5 in wrong position. n. Faulty fuse 2F1. m. Defective POWER ON switch 2S6. 	<ul style="list-style-type: none"> a. Replace power cable B160833. b. Replace power jumper cord B160826 c. Replace fuse A1F1. d. Set VOLTAGE SET switch to proper voltage setting. e. Replace 1A1 (see paragraph 4-6b.) f. Replace 1A2 (see paragraph 4-6c.) g. Replace lamp 1DS1. h. Replace 1A3 (see paragraph 4-6d.). i. Replace 1A3 (see paragraph 4-6d.). j. Replace 2DS1. k. Set SELECTOR switch 2S5 to proper position. l. Replace fuse 2F1. m. Replace Model MD-1075/URM (see paragraph 4-6a.).
2	Unit operating but FAN 1B1 not operating	<ul style="list-style-type: none"> a. FREQ SET 50/60 -400 Hz switch 1A1S3 in wrong position. b. FREQ SET 50/60 -400 Hz switch 1A1S3 defective. 	<ul style="list-style-type: none"> a. Set switch 1A1S3 to proper position.* b. Replace 1A1 (see paragraph 4-6b.).*

*Serial Numbers 2-60A thru 2-117A

TABLE 4-2. TROUBLESHOOTING CHART (Continued)

Step	Symptom	Probable Cause	Corrective Action
2 (cont'd)		c. 60 to 400 Hz Converter Board 1A10 defective d. Defective fan 1B1 e. Defective cable assembly 1W1	c. Replace 1A10 (see paragraph 4-6i.)* d. Replace fan 1B1 e. Replace cable assembly 1W1
3	CW operation: No meter CAL obtainable	a. No RF OUTPUT (measure rf power at the RF OUTPUT connector) (1) Faulty fuse 1A4F1 (2) Faulty fuse 1A4F2 (3) Faulty fuse 1A3F1* (4) No 6.3 vdc filament voltage between pins 2 and 3 of connector 1A3J3 (5) No beam voltage (- 1250 V) between pin 3 or 4 of connector 1A3J3 and ground (6) No repeller voltage between pin 3 of connector 1A3J5 and ground. <p style="text-align: center;">Note</p> ΔF control should be turned fully clockwise to measure -1850 V. (7) No beam current (Measure voltage between ground and 1A4TP4) (8) No oscillator power supply voltage (+30 V) between ground and 1A4TP1	(1) Replace fuse 1A4F1 (2) Replace fuse 1A4F2 (3) Replace fuse 1A3F1* (4) See Step 4 (5) See Step 6 (6) See Step 7 (7) See Step 9 (8) See Step 5

*Serial Numbers 2-60A thru 2-117A

TABLE 4-2. TROUBLESHOOTING CHART (Continued)

step	Symptom	Probable cause	Corrective Action
3 (cont'd)		<p>(9) Modes do not track</p> <p>(10) Defective tracking potentiometer 1A7R1</p> <p>(11) RF attenuator probe 1W15 defective</p> <p>(12) Defective klystron 1V1</p> <p>(13) Delay circuit inoperative (Voltage measured between 1A4TP3 and ground does not go to 0 volts after 60 seconds)</p> <p>(14) Amplifier circuits inoperative</p> <p>(15) Switch 1A3S1 defective</p> <p>(16) No +40 V supply voltage for the amplifier circuit. (Measure voltage between pins 3 and 4 of connector 1A3J3 with pin 4 as negative)</p> <p>b. Defective metering circuit</p> <p>(1) Defective detector 1Z1</p> <p>(2) Defective power monitor meter 1A8M1</p> <p>(3) Defective probe 1W9. (Measure 50 ohms between ground and center conductor of probe connector 1W9P7)</p>	<p>(9) Diagnose only. Return to depot for repair.</p> <p>(10) Diagnose only. Return to depot for repair.</p> <p>(11) Diagnose only. Return to depot for repair.</p> <p>(12) Diagnose only. Return to depot for repair.</p> <p>(13) Replace 1A4 (see paragraph 4-6i.)</p> <p>(14) Replace 1A3 (see paragraph 4-6d.)</p> <p>(15) Replace 1A3 (see paragraph 4-6d.)</p> <p>(16) See Step 8</p> <p>(1) Diagnose only. Return to depot for repair.</p> <p>(2) Replace 1A8 (see paragraph 4-6M.)</p> <p>(3) Diagnose only. Return to depot for repair</p>

TABLE 4-2. TROUBLESHOOTING CHART (Continued)

Step	Symptom	Probable Cause	Corrective Action
3 (cont'd)		(4) Broken wires on 1A8 (5) Defective meter CAL adjust potentiometer 1A3R3	(4) Replace 1A8 (see paragraph 4-6h.) (5) Replace 1A3 (see paragraph 4-6d.)
4	No filament voltage	a. No voltage (ac) at connector 1A3J1 b. Defective 1A3BR1, 1A3U1 and associated circuitry c. 6.3 V ADJ potentiometer 1A3R1 improperly adjusted	a. Replace 1A2 (see paragraph 4-6c.) b. Replace 1A3 (see paragraph 4-6d.) c. Adjust per paragraph 4-7e.)
5	No oscillator power supply voltage (+30 V)	a. Faulty fuse 1A4F1 b. No ac voltage at connector 1A4J1 c. Defective 1A4BR1, 1A4Q4, 1A4Q5 and associated circuitry	a. Replace fuse 1A4F1 b. Replace 1A2 (see paragraph 4-6c.) c. Replace 1A4 (see paragraph 4-6e.)
6	No beam voltage (-1250V) NOTE: Check Steps 7 and 8 as they are inter-related.	a. Defective H.V. Box 1A5 b. Defective 1A4U3 c. -1250 volts improperly set	a. Replace 1A5 (see paragraph 4-6a.) b. Replace 1A4 (see paragraph 4-6e.) c. Adjust per paragraph 4-7b.
7	No repeller voltage supply (-1850V)	a. Defective H.V. Box 1A5 b. Defective repeller supply regulator	a. Replace 1A5 (see paragraph 4-6f.) b. Replace 1A3 (see paragraph 4-6d.)
8	No +40 V supply for amplifier circuit	Defective H.V. Box 1A5	Replace 1A5 (see paragraph 4-6f.)
9	No or low beam current	a. Defective operational amplifier 1A5A2U1 b. Beam current improperly adjusted	a. Replace 1A5 (see paragraph 4-6f.) b. Adjust per paragraph 4-7d.)

TABLE 4-2. TROUBLESHOOTING CHART (Continued)

step	Symptom	Probable Cause	Corrective Action
9 (cont'd)		<ul style="list-style-type: none"> c. Defective Schmitt trigger 1A3U2 and output amplifier circuit W1A3Q1 d. Defective klystron 1V1 	<ul style="list-style-type: none"> c. Replace 1A3 (see paragraph 4-6d.) d. Diagnose only. Return to depot for repair.
10	CW Operation: Meter CAL functioning but dB error functioning	<ul style="list-style-type: none"> a. Defective RF attenuator probe 1W1 5 b. Defective power set probe 1W9 c. Defective detector 1Z1 	<ul style="list-style-type: none"> a. Diagnose only. Return to depot for repair. b. Diagnose only. Return to depot for repair. c. Diagnose only. Return to depot for repair
11	Frequency range not according to specifications	Frequency cam out of alignment	Diagnose only. Return to depot for repair.
12	No internal pulse modulation	<ul style="list-style-type: none"> a. Defective Modulator MD-1075/URM b. Defective amplifier circuitry (1A3Q1) and associated circuitry or 1A3U2 c. Defective video cable C147363 d. Broken wire on Pushbutton Board Assy 1A3 e. Defective switch 1A3S1 	<ul style="list-style-type: none"> a. Replace Modulator MD-1075/URM (see paragraph 4-6a.) b. Replace 1A3 (see paragraph 4-d.) c. Replace cable d. Replace 1A3 (see paragraph 4-6d.) e. Replace 1A3 (see paragraph 4-6d.)
13	No internal square wave modulation	<ul style="list-style-type: none"> a. Defective Modulator MD-1075/URM b. Defective amplifier circuit (1A3Q1) and associated circuitry or 1A3U2 	<ul style="list-style-type: none"> a. Replace Modulator MD-1075/URM (see paragraph 4-6a.) b. Replace 1A3 (see paragraph 4-6d.)

TABLE 4-2. TROUBLESHOOTING CHART (Continued)

Step	Symptom	Probable Cause	Corrective Action
13 (cont'd)		<ul style="list-style-type: none"> c. Defective video cable C147363 d. Broken wire on Pushbutton Board Assy 1A3 e. Defective switch 1A3S1 	<ul style="list-style-type: none"> c. Replace cable d. Replace 1A3 (see paragraph 4-6d.) e. Replace 1A3 (see paragraph 4-6d.)
14	No external pulse modulation	Same as Step 12	Same as Step 12
15	No internal FM operation (AN/URM-206)	<ul style="list-style-type: none"> a. Defective Modulator MD-1075/URM b. Defective video cable C147363 (between FM OUT and EX FM connectors) c. Defective amplifier circuitry (1A3Q1 and associated circuitry or 1A3U2) d. Defective switch 1A3S1 e. Broken wire on Pushbutton Board Assembly 1A3 	<ul style="list-style-type: none"> a. Replace Modulator MD-1075/URM (see paragraph 4-6a.) b. Replace cable c. Replace 1A3 (see paragraph 4-6d.) d. Replace 1A3 (see paragraph 4-6d.) e. Replace 1A3 (see paragraph 4-6d.)
16	No internal FM (Model SG-1145/URM)	<ul style="list-style-type: none"> a. Defective amplifier circuit (1A3Q1 and associated circuitry or 1A3U2) b. Defective switch 1A3S1 c. No ac voltage between pin 2 of 1A3U2 and ground d. Broken terminal T3, T4, and T5 on Pushbutton Board Assy 1A3 e. Defective in FM DEV potentiometer 1A3R16 	<ul style="list-style-type: none"> a. Replace 1A3 (see paragraph 4-6d.) b. Replace 1A3 (see paragraph 4-6d.) c. Replace 1A2 (see paragraph 4-6c.) d. Replace 1A3 (see paragraph 4-6d.) e. Replace 1A3 (see paragraph 4-6d.)

TM11-6625-2948-14+P

TABLE 4-2. TROUBLESHOOTING CHART (Continued)

Step	Symptom	Probable Cause	Corrective Action
16 (cont'd)		f. Defective FM INT RANGE ADJ potentiometer 1A3R17	f. Replace 1A3 (see paragraph 4-6d.)
17	No external FM operation	a. Defective amplifier circuitry (1A3Q1 and associated circuitry or 1A3U2) b. Defective switch 1A3S1 c. Broken wire on Pushbutton Board Assy 1A3	a. Replace 1A3 (see paragraph 4-6d.) b. Replace 1A3 (see paragraph 4-6d.) c. Replace 1A3 (see paragraph 4-6d.)
18	No internal sync undelayed output	Defective Modulator MD-1075/URM	Replace Modulator MD-1075/URM (see paragraph 4-6a.)
19	No delayed rf pulses	Defective Modulator MD-1075/URM	Replace Modulator MD-1075/URM (see paragraph 4-6a.)
20	No external sync operation with sine waves	Defective Modulator MD-1075/URM	Replace Modulator MD-1075/URM (see paragraph 4-6a.)
21	No external sync operation with pulses	Defective Modulator MD-1075/URM	Replace Modulator MD-1075/URM (see paragraph 4-6a.)

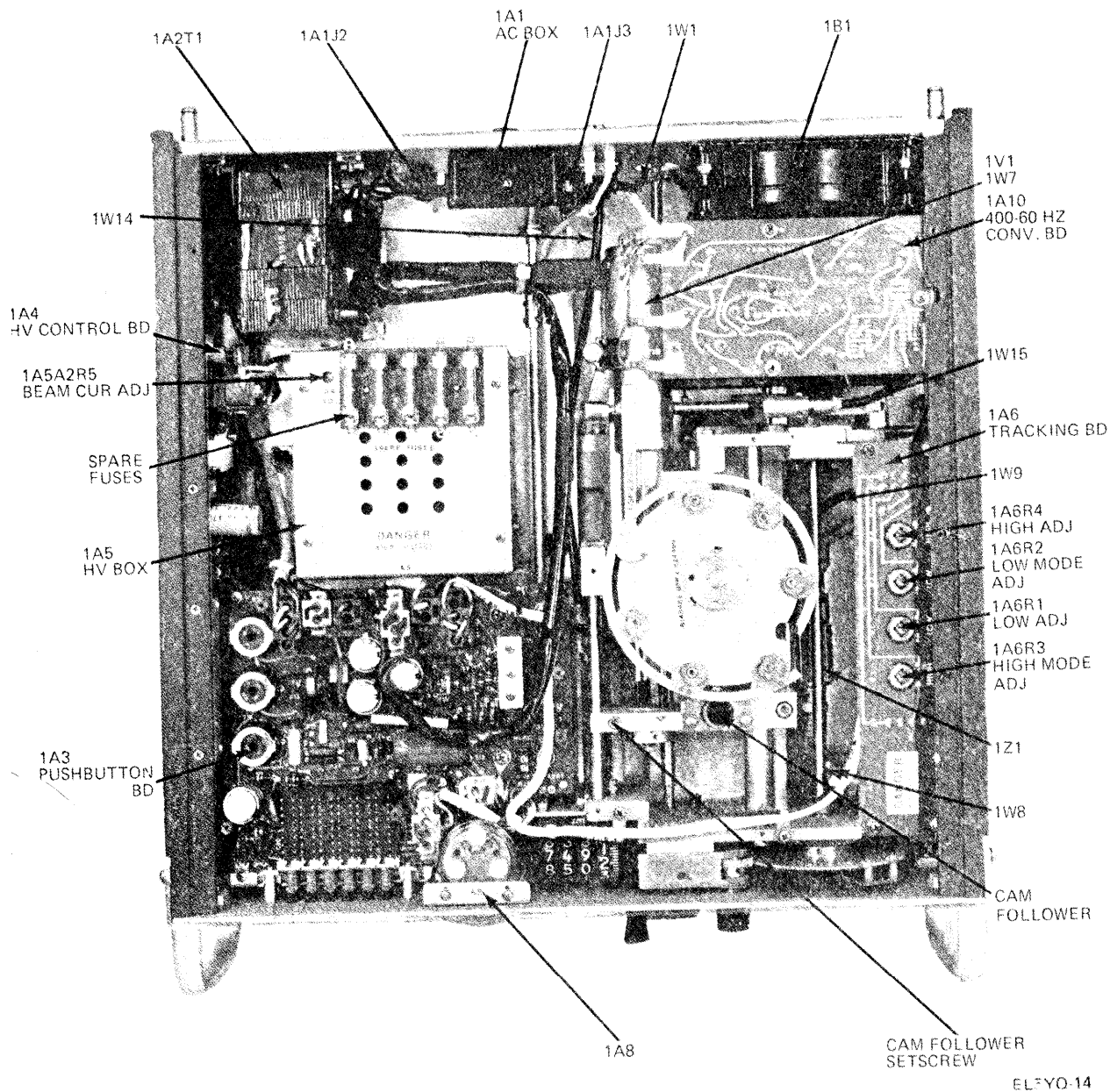

EL YO-14

Figure 4-6. Signal Generator SG-1145/URM Chassis, Top View

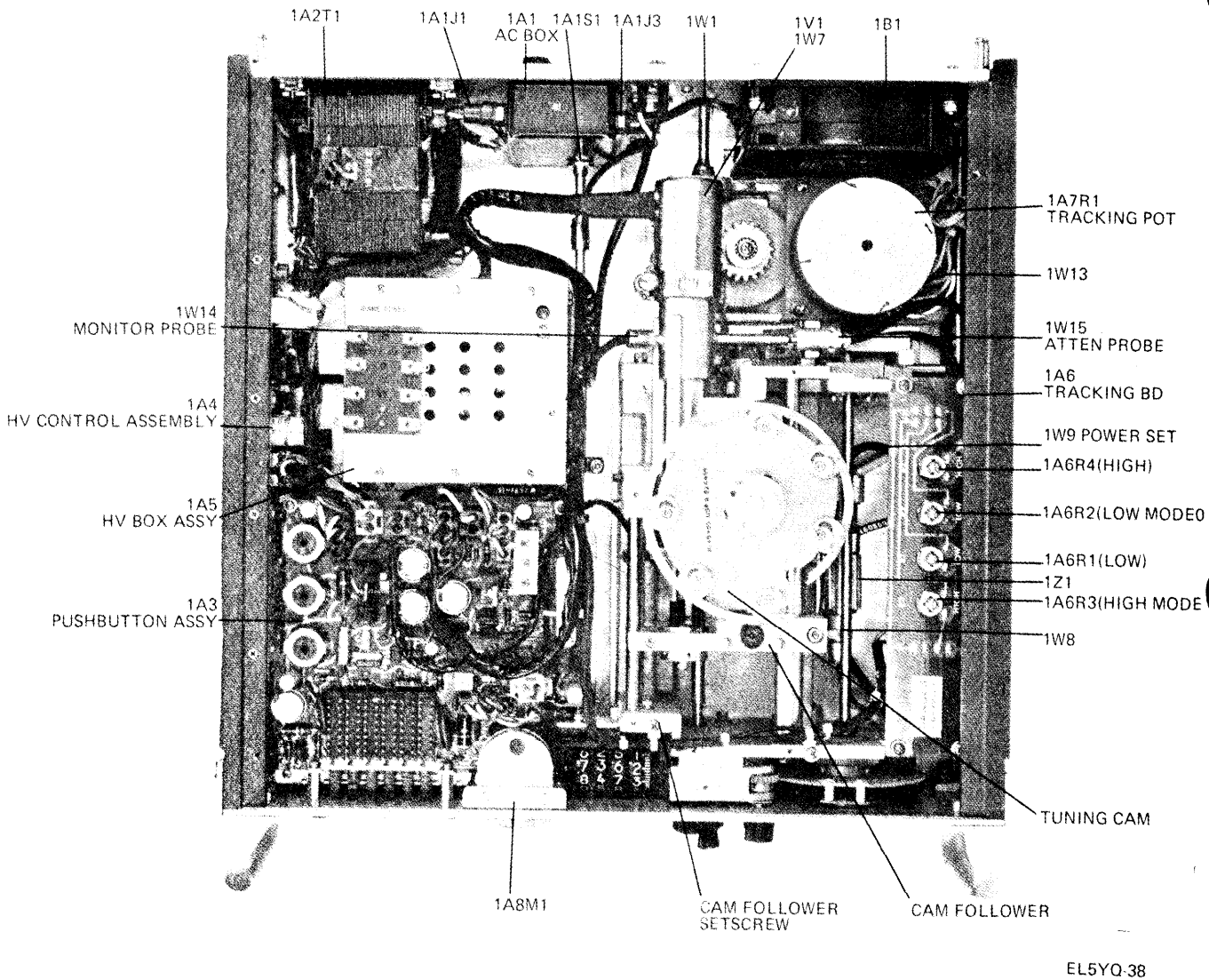

EL5YQ-38

Figure 4-6.1. Signal Generator SG-1145/URM Chassis, Top View (Serial No. 5-201B thru 5-511B)

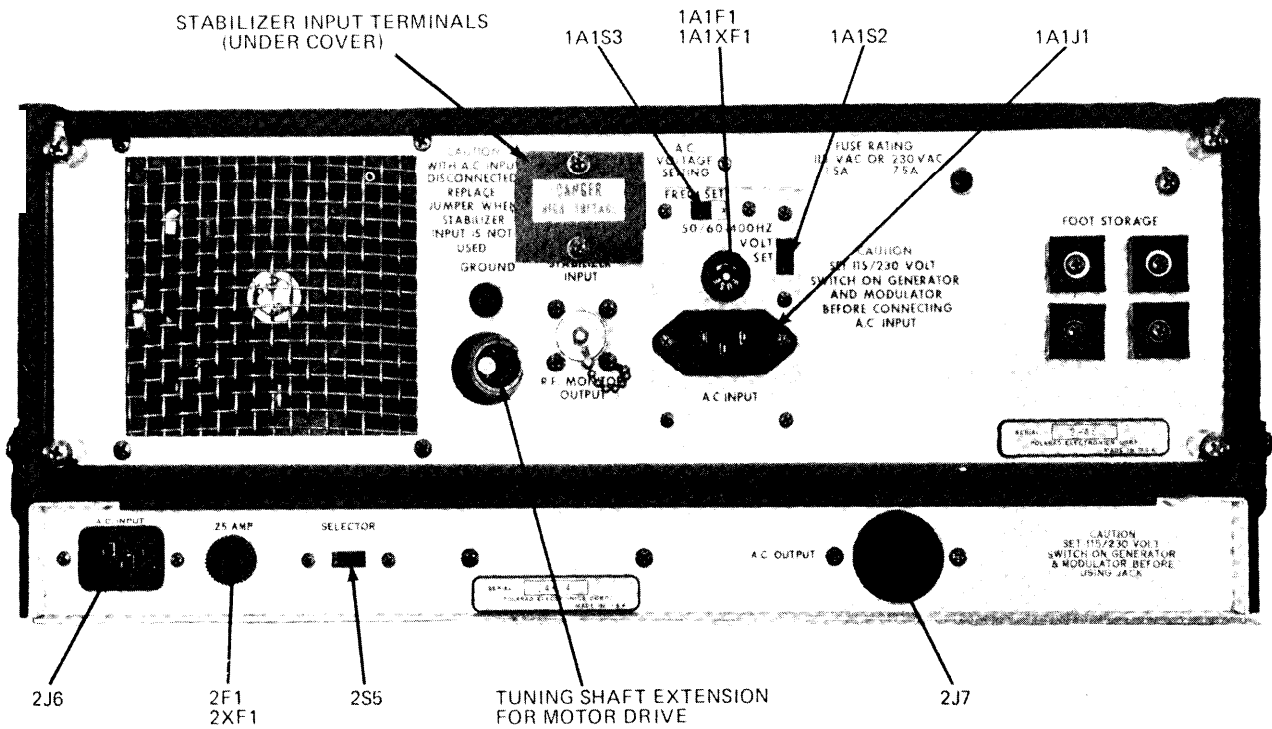

EL-YQ 15

Figure 4-7. Signal Generator AN/URM-206 Chassis, Rear View

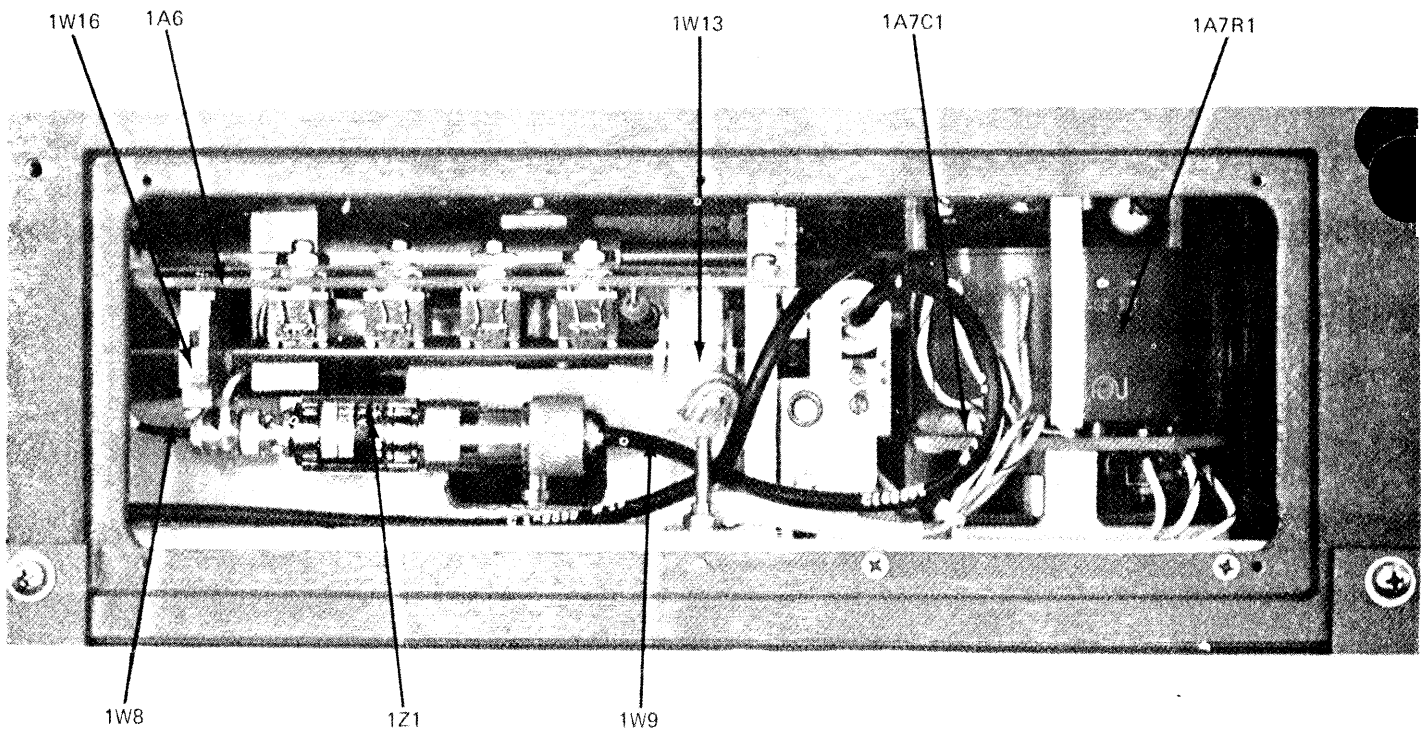

EL *

Figure 4-8. Signal Generator SG-1145/URM Chassis, Side View

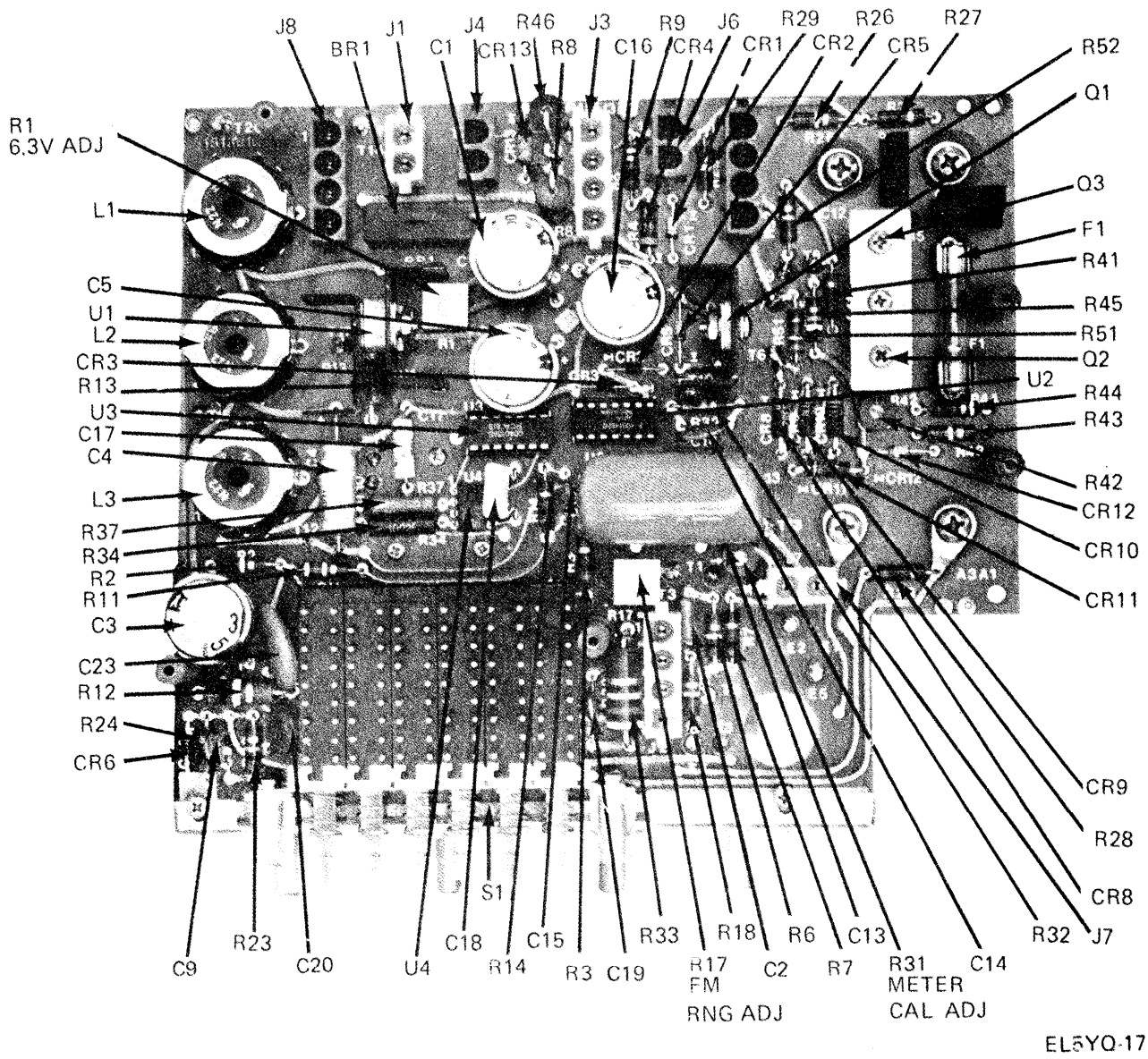

Figure 4-9. Pushbutton Board Assembly 1A3, Component Location, Top View

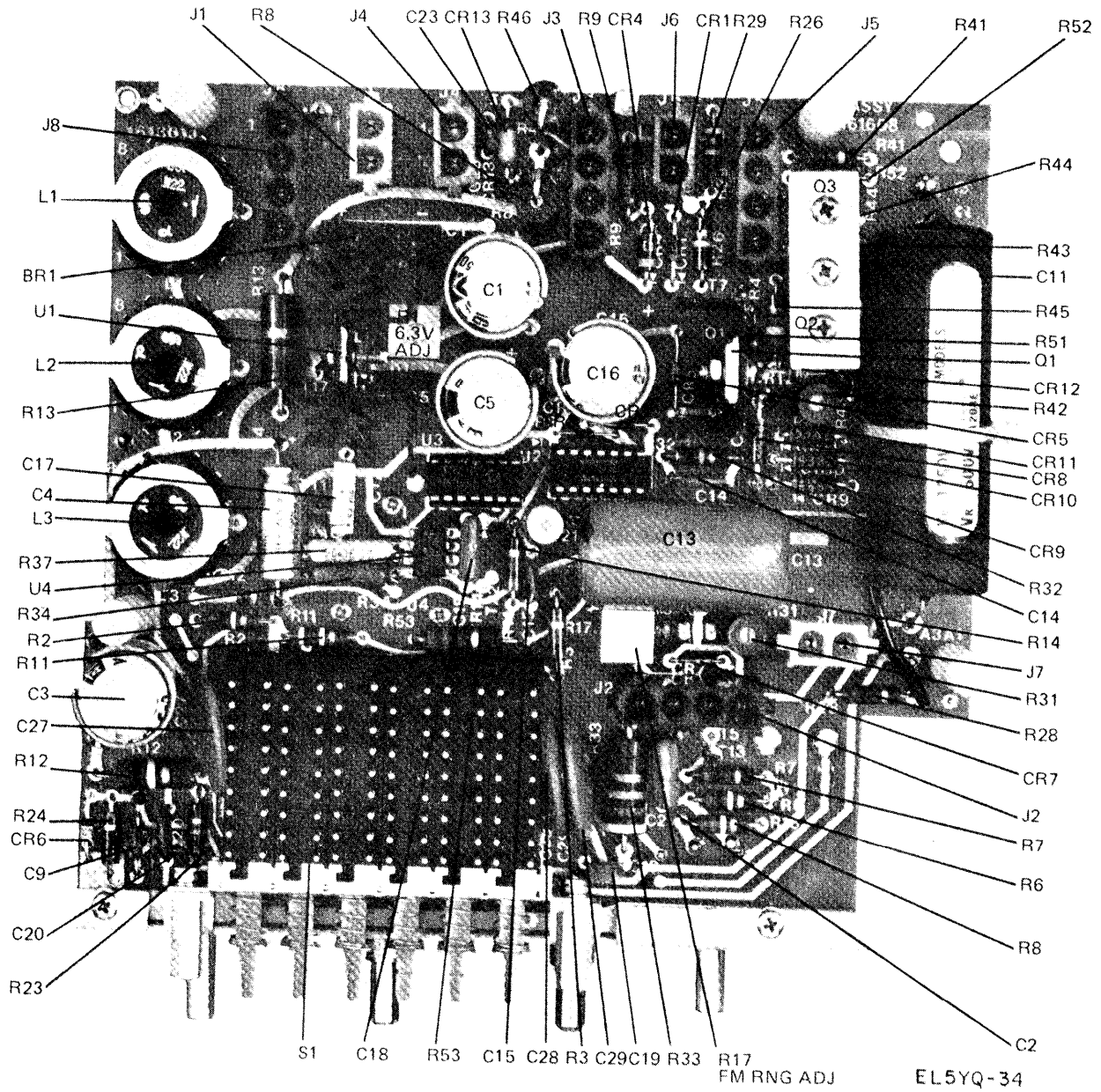
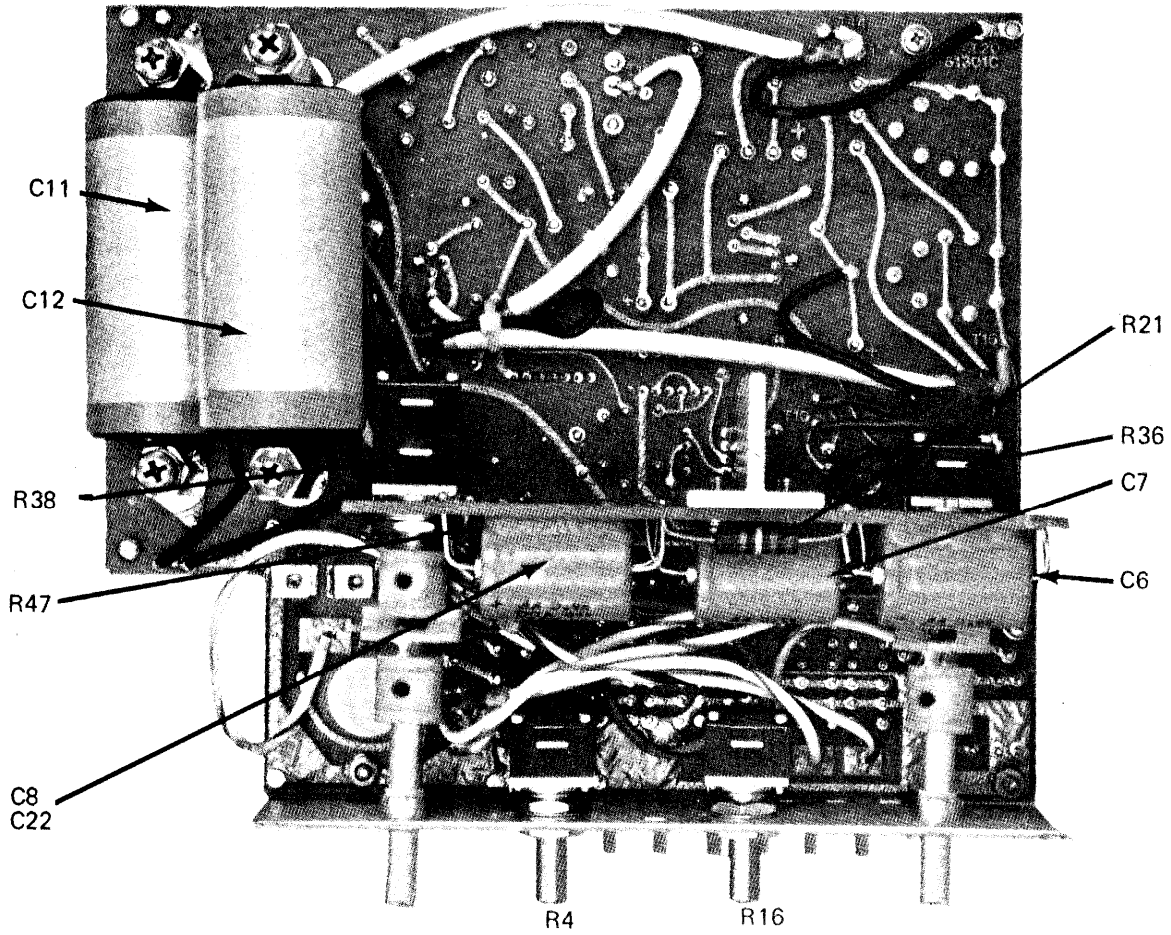

Figure 4-9.1. Pushbutton Board Assembly 1A3, Component Location, Top View
Serial Nos. 5-201B Thru 5-511B



EL5YQ-18

Figure 4-10. Pushbutton Board Assembly 1A3, Component Location, Bottom View

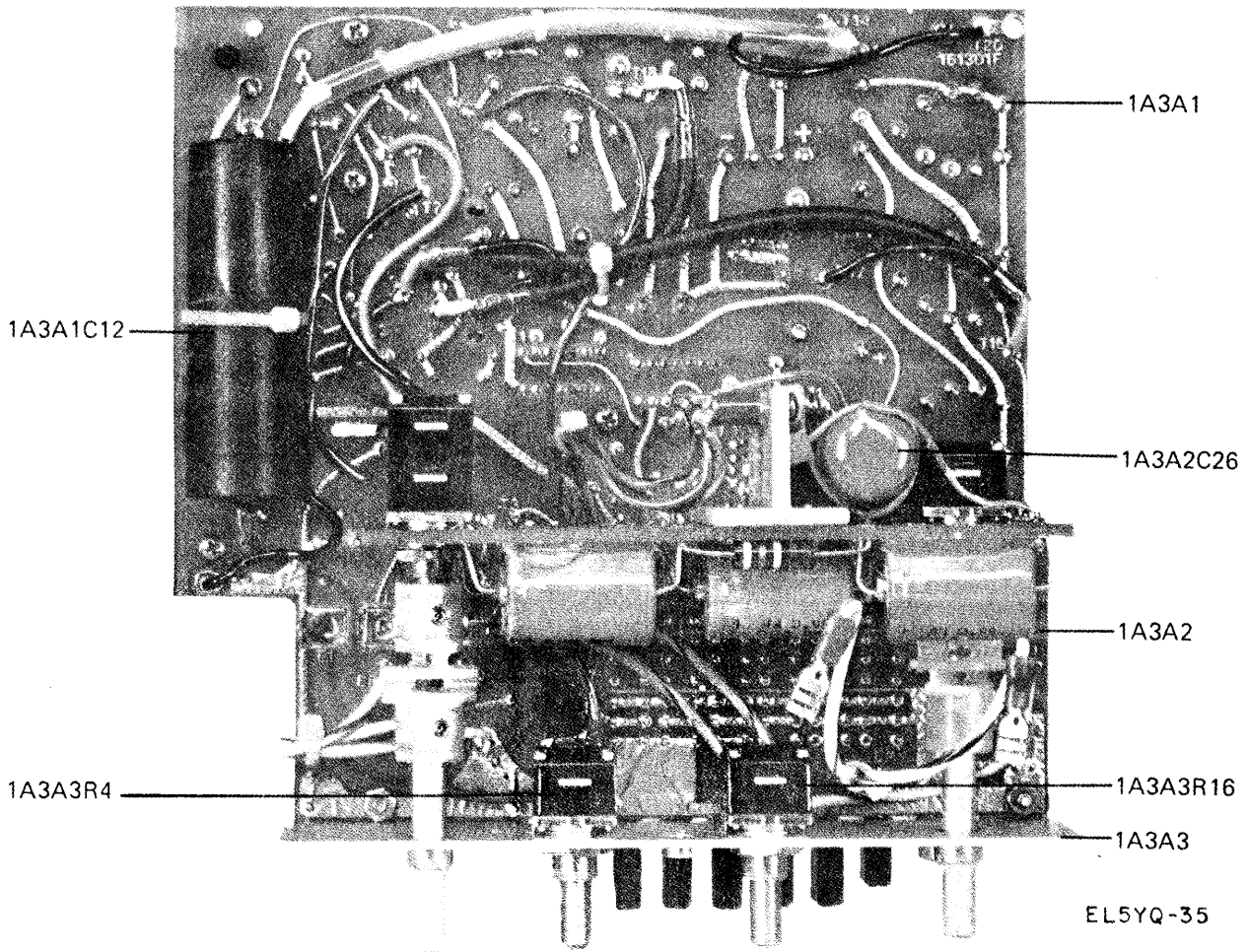
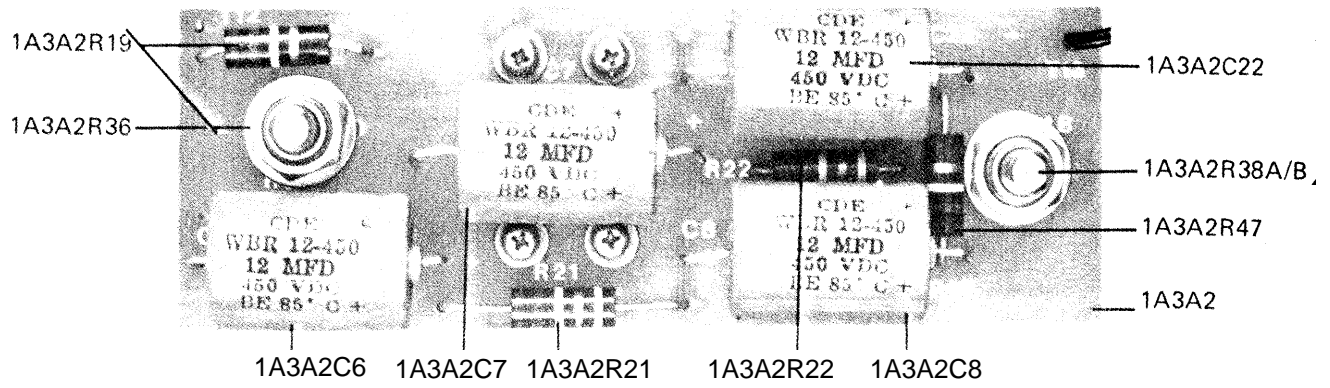
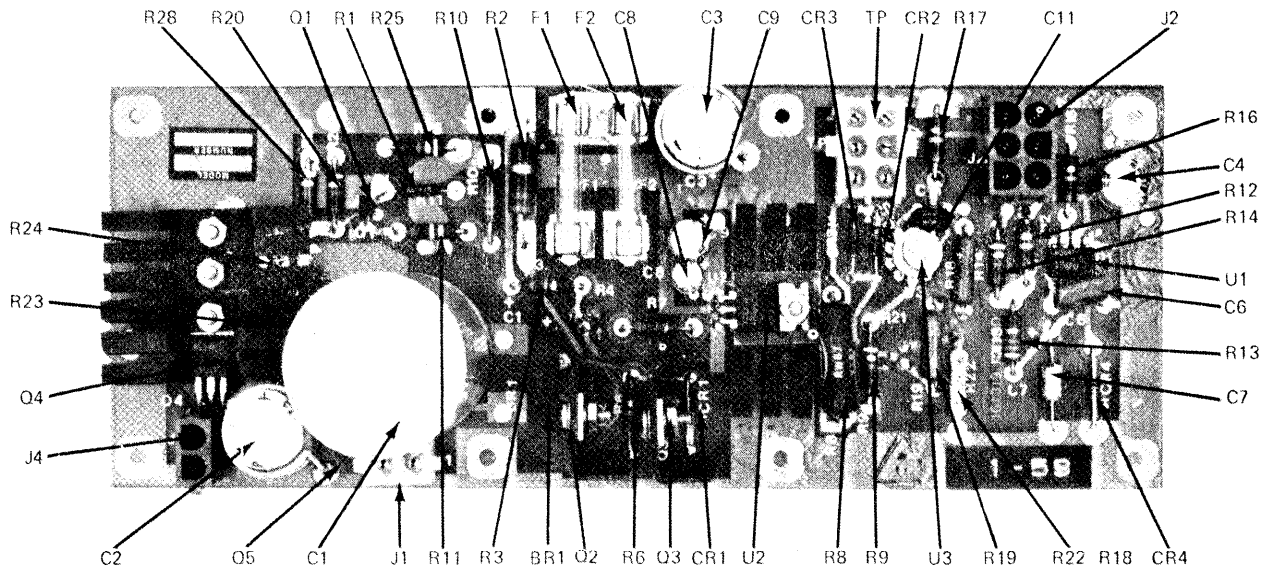
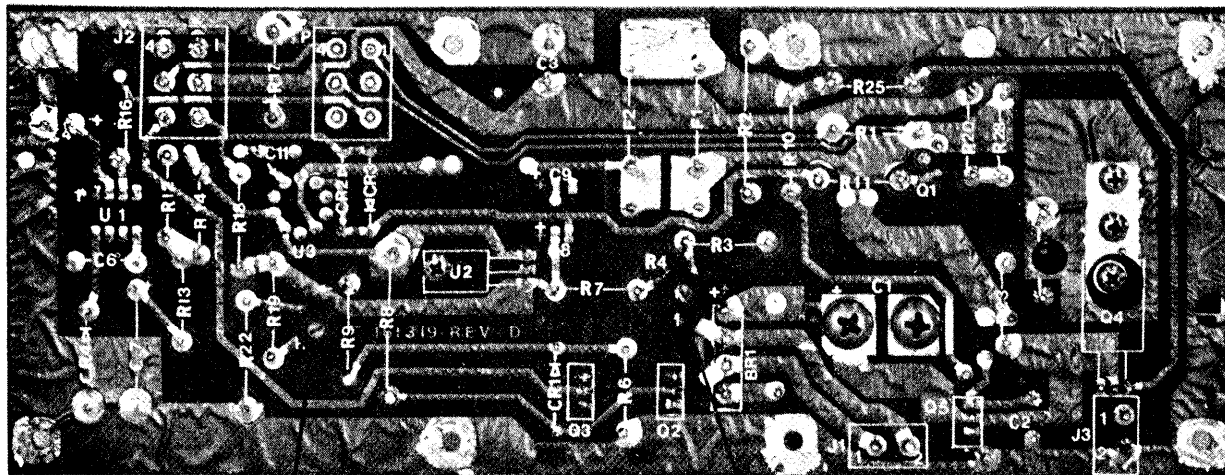

Figure 4-10.1. Pushbutton Board Assembly 1A3, Component Location, Bottom View
Serial Nos. 5-201B thru 5-511B



EL5YQ.19

Figure 4-11. High Voltage Control Board Assembly 1A4, Component Layout



EL5YQ.20

Figure 4-11. High Voltage Control Board Assembly 1A4, Component Layout

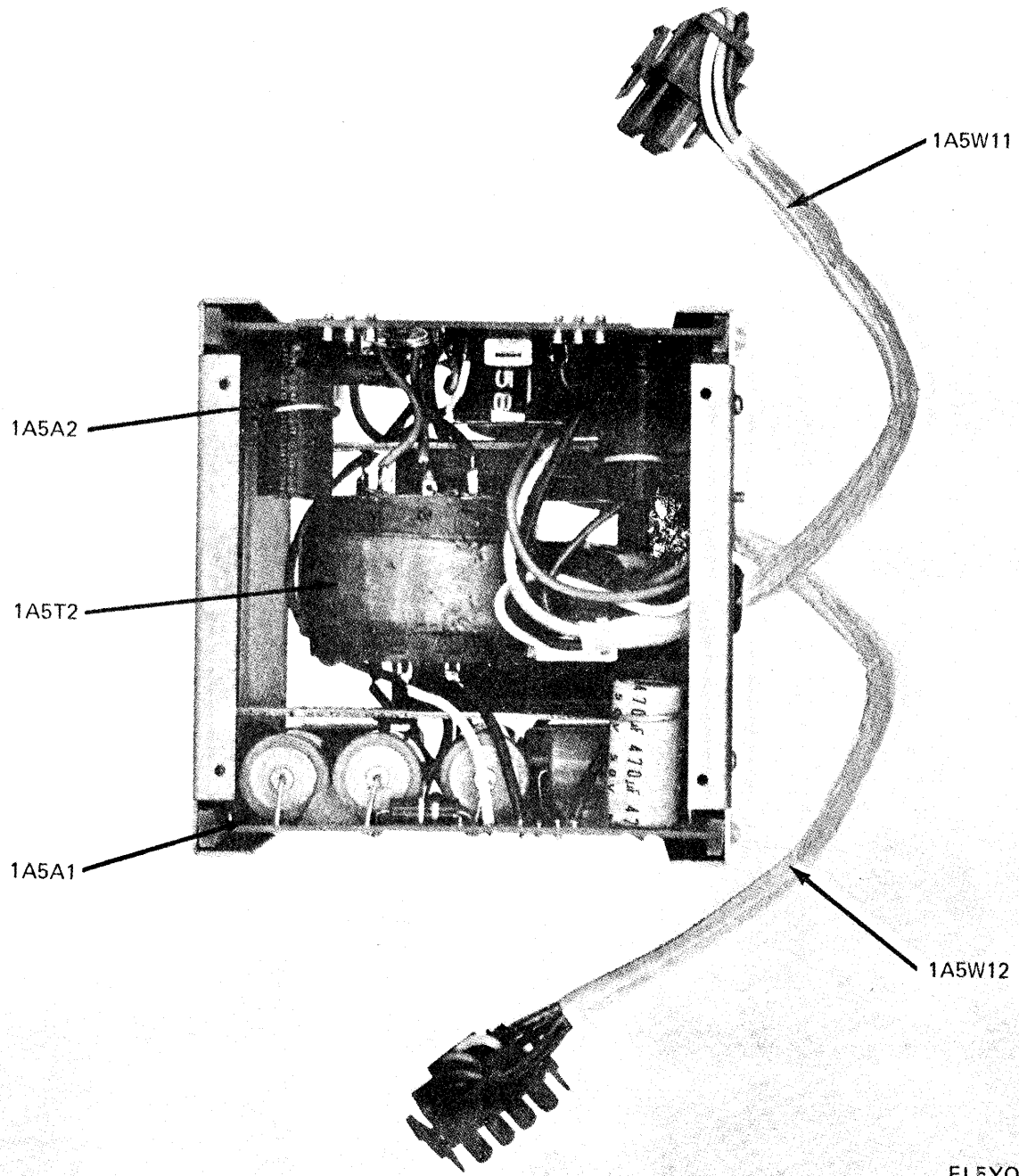
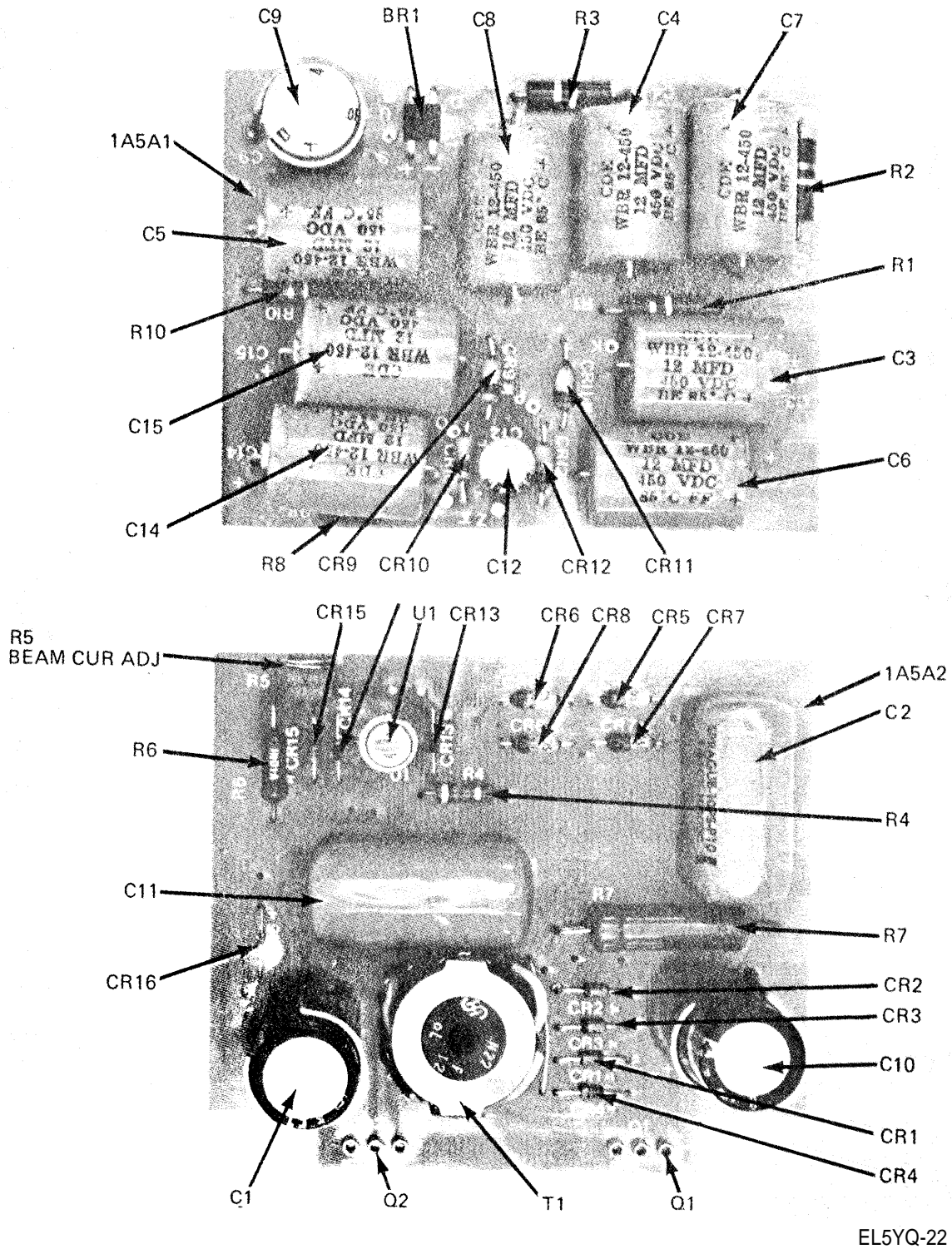

Figure 4-12. High Voltage Box 1A5, Component Layout (Sheet 1 of 2)



EL5YQ-22

Figure 4-12. High Voltage Box 1A5, Component Layout (Sheet 2 of 2)

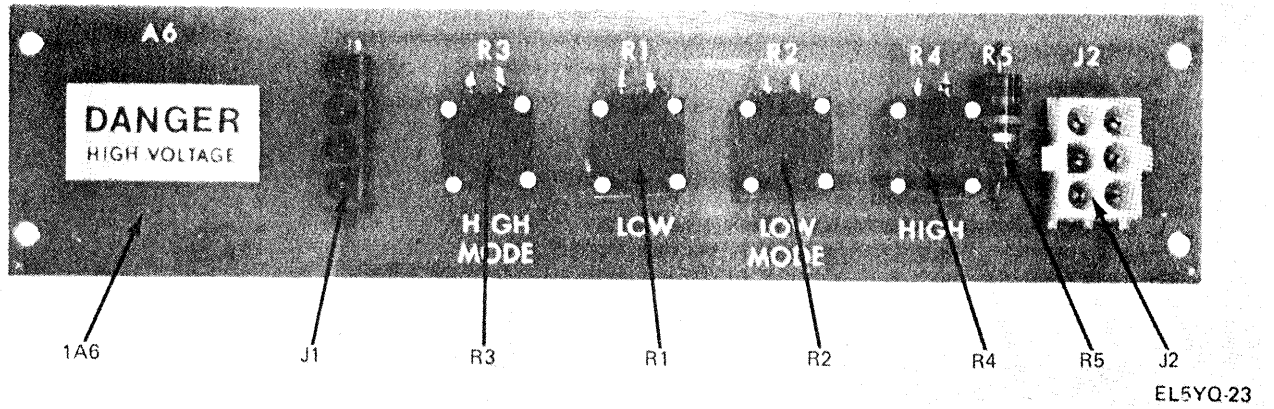
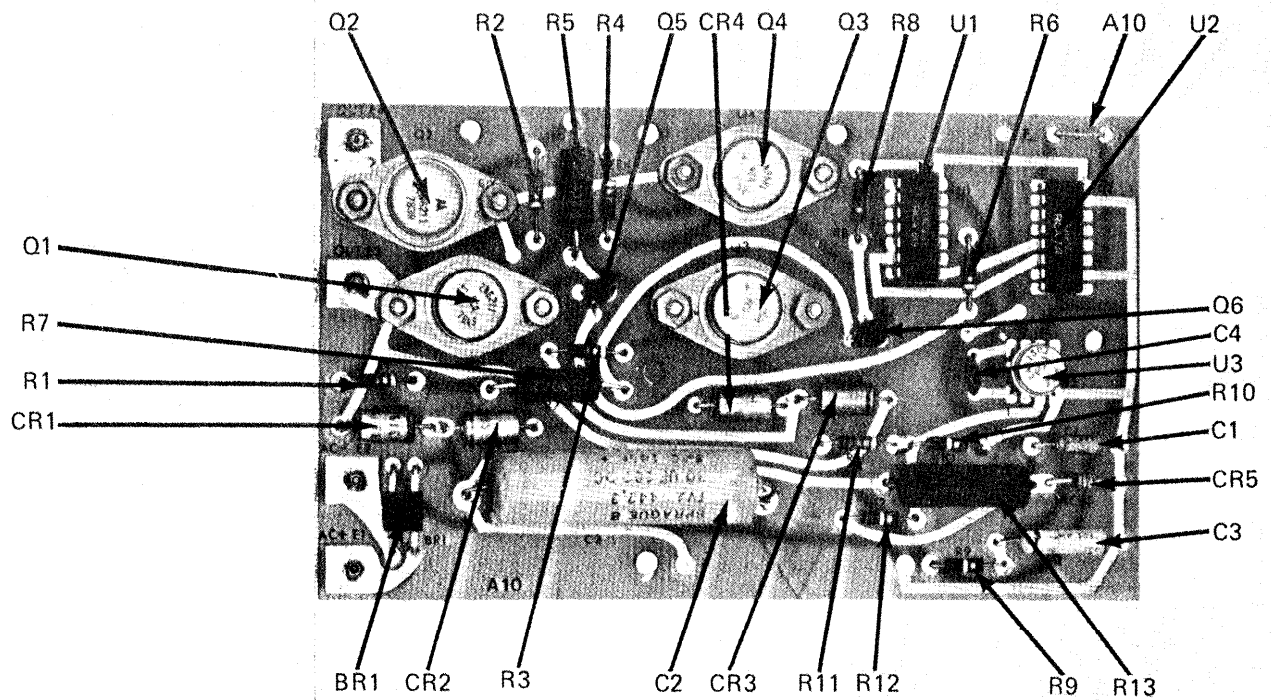
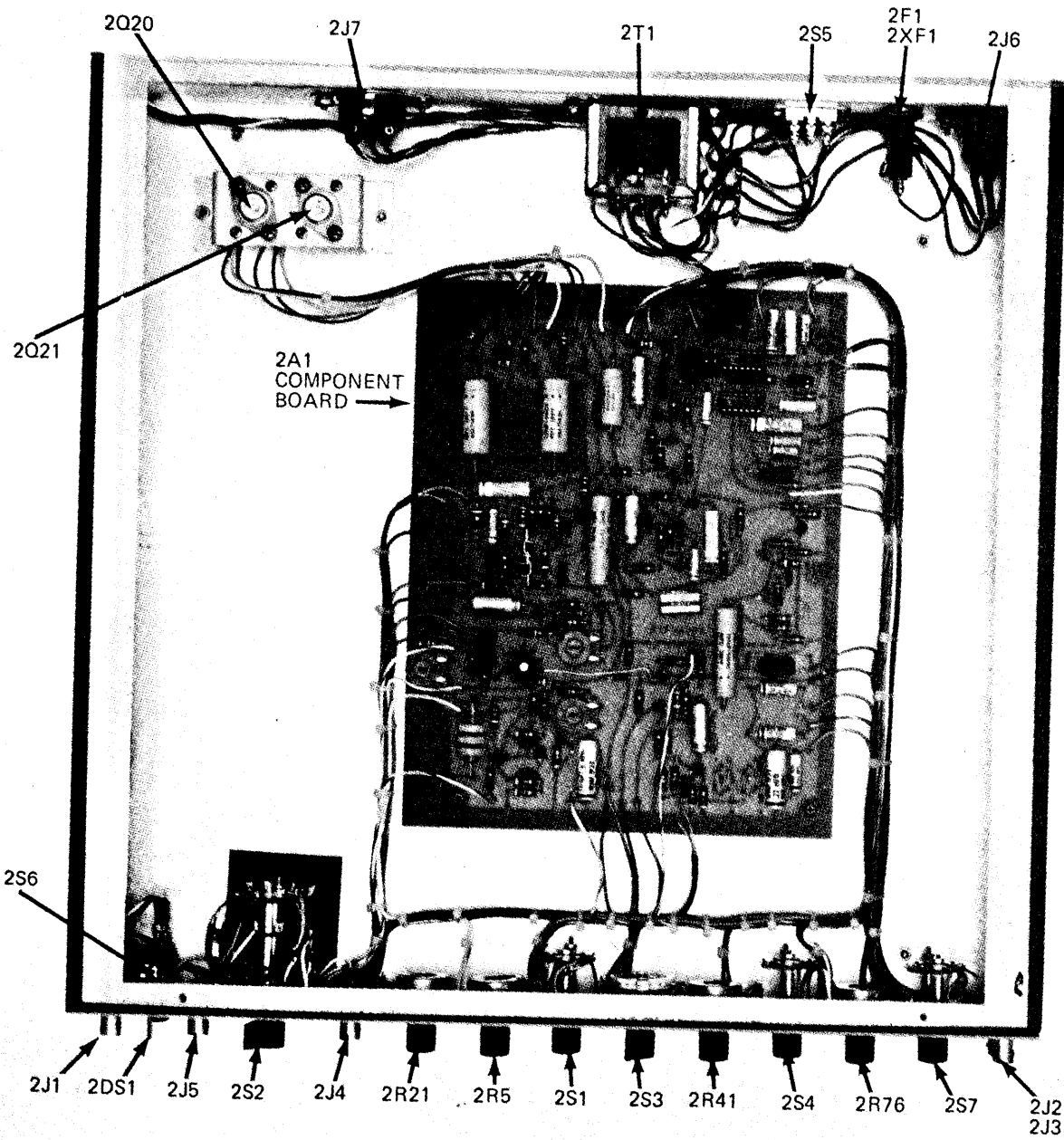

Figure 4-13. Tracking Board Assembly 1A6, Component Layout



EL5YQ-24

Figure 4-14. 400-60 Hz Converter Board 1A10, Component Layout



EL5YQ-25

Figure 4-15. Modulator MD-1075/URM, Top View

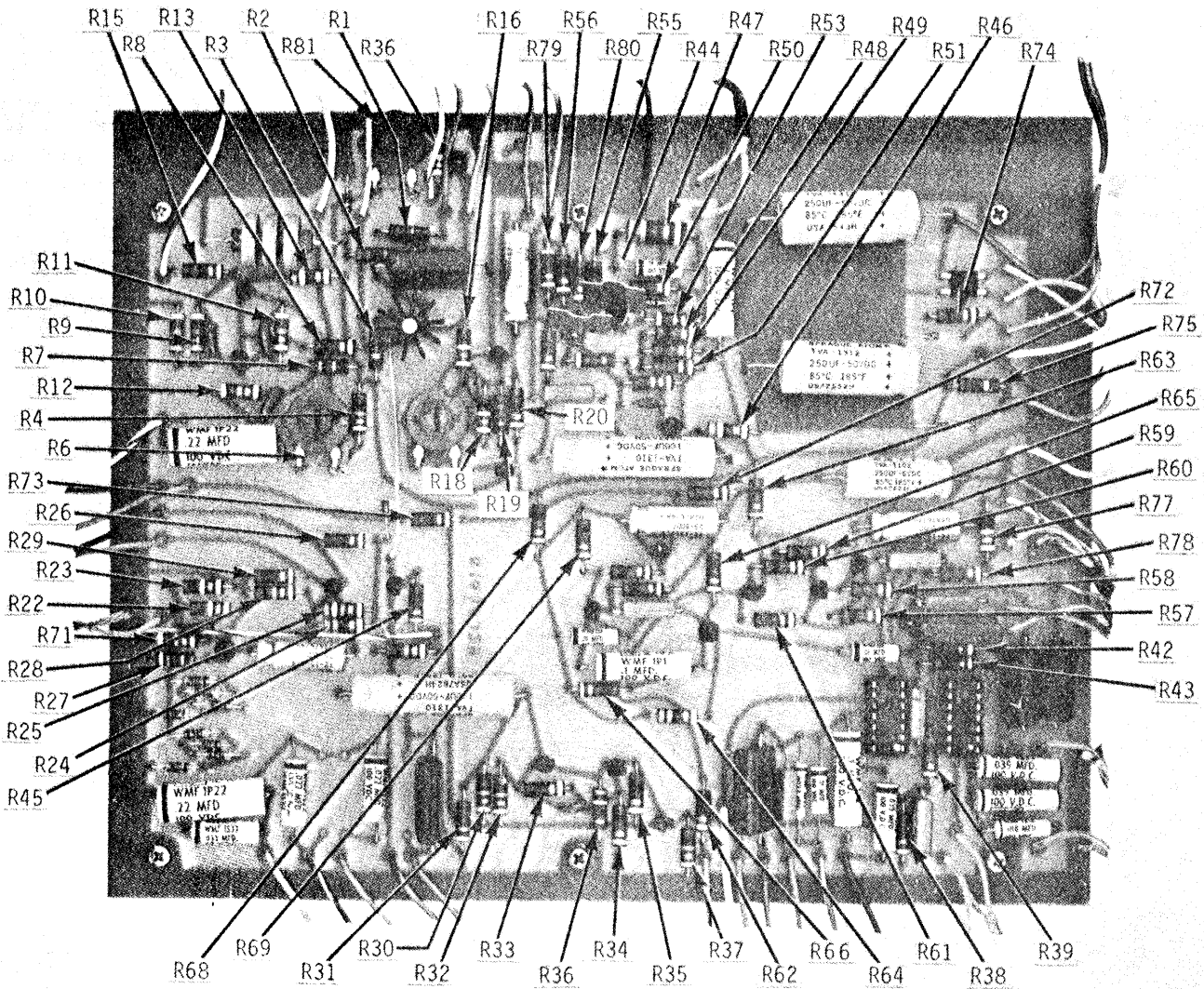

EL5YQ-26

Figure 4-16. Modulator Component Board, Component Layout, Part 1

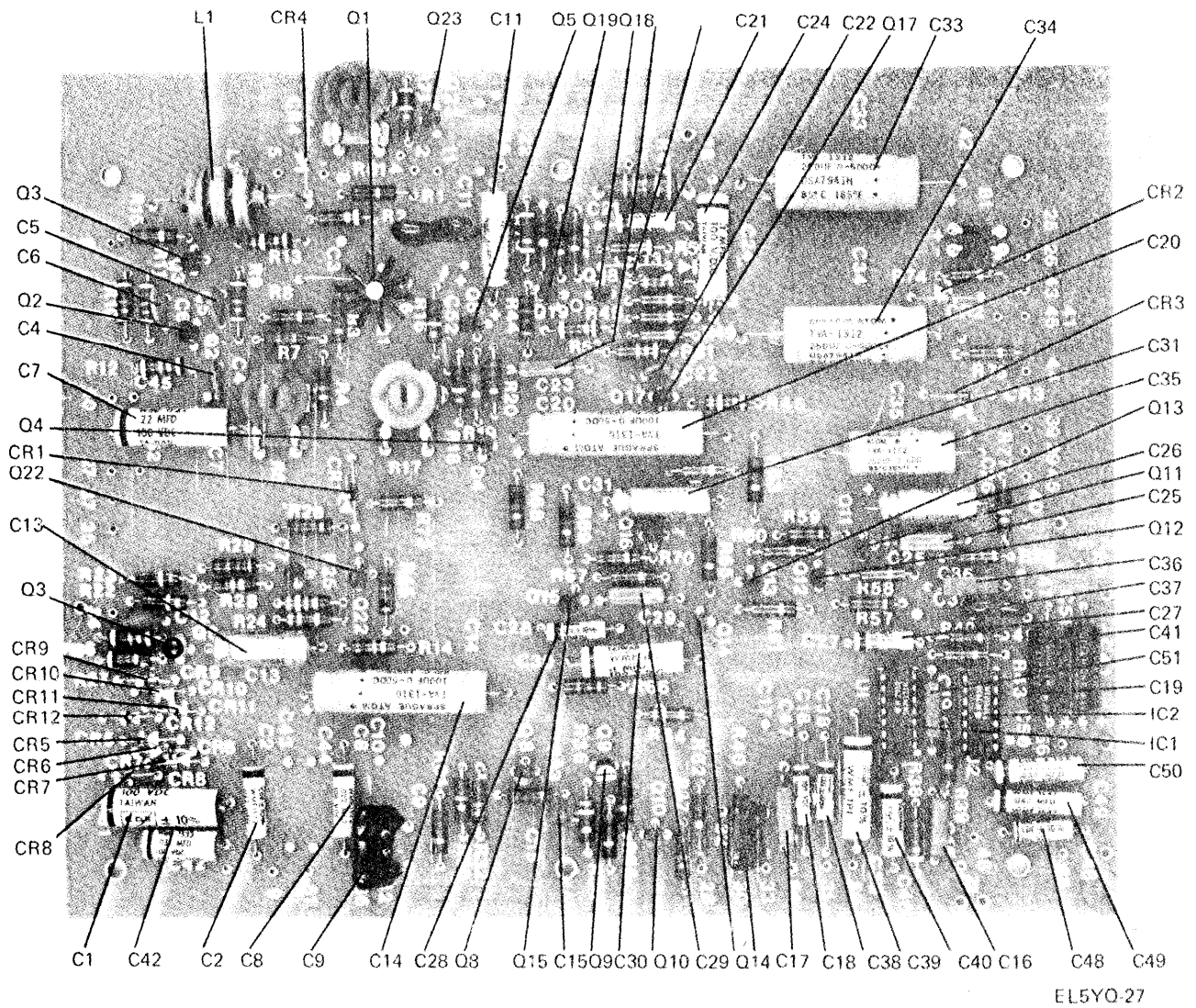

Figure 4-16. Modulator Component Board, Component Layout, Part 2

4-6. REMOVAL AND REPLACEMENT INSTRUCTIONS

Removal and replacement instructions for the instrument are given in paragraph a. through j. Component locations are shown in figures 4-6 through 4-16.

NOTE

Do not disassemble the instrument beyond the point at which the necessary repair or replacement can be made. Perform the applicable minimum performance tests after any replacement procedure given below. Certain pieces of hardware may be Glyptol-locked. Before removing these pieces of hardware be sure to use the proper tools so as not to damage the component.

WARNING

BEFORE ATTEMPTING ANY DISASSEMBLY OR REASSEMBLY PROCEDURES MAKE SURE THAT THE POWER SWITCHES ON THE MODEL MD-1075/URM AND SG-1145/URM ARE IN THEIR OFF POSITIONS AND THE POWER CORD HAS BEEN DISCONNECTED FROM THE POWER SOURCE.

a. Removal and Replacement of Signal Generator SG-1145/URM or Modulator MD-1075/URM.

- (1) Set POWER switches on signal generator SG-1145/URM and Modulator MD-1075/URM to their OFF positions.
- (2) Disconnect power cord B160833 from power source and AC INPUT connector on Modulator MD-1075/URM.
- (3) Disconnect power jumper cable B160826 from the AC INPUT connector on Signal Generator SG-1145/URM and the AC OUTPUT connector on Modulator MD-1075/URM.
- (4) Remove the four mounting brackets, B165654, and associated hardware that attach the brackets to the signal generator and the modulator (see fig. 2-1).
- (5) Remove the instrument that is to be replaced.

(6) Replacement procedures for the unit are the reverse of the removal procedures.

(7) After replacing the unit, perform the operations procedures from paragraph 2-4.

b. Removal and Replacement of AC Box Assembly 1A1 (fig. 4-6 and 4-6.1)

- (1) Perform steps (1), (2) and (3) of paragraph 4-60.
- (2) Remove the top cover of Signal Generator SG-1145/URM.
- (3) Loosen the setscrews that hold the shaft of the POWER ON switch.
- (4) Remove the three screws that mount the AC box assembly 1A1 (fig. 4-6) to the rear of the chassis.
- (5) Disconnect connectors from connectors 1A1J2 and 1A1J3.
- (6) Replacement procedures are the reverse of the removal procedures.

c. Removal and Replacement of Power Transformer Assembly 1A2 (fig. 4-6 and 4-4.1).

- (1) Perform all of paragraph 4-6a.
- (2) Remove the top and bottom cover of Signal Generator SG-1145/URM.
- (3) Disconnect connectors 1A2P3, 1A2P4, and 1A2P5. Connectors 1A2P3 and 1A2P4 go to pushbutton board assembly 1A3 and connector 1A2P5 goes to high voltage control board 1A4.
- (4) Remove the four screws that mount the transformer to the chassis bottom and two screws that mount to the chassis rear.
- (5) Replacement procedures are the reverse of the removal procedures.

d. Removal and Replacement of Pushbutton Board Assembly 1A3 (fig. 4-6 and 4-6.1).

- (1) Perform all steps in paragraph 4-6a.

(2) Remove the top and bottom cover of Signal Generator SG-1145/URM.

WARNING

DISCHARGE ALL HIGH VOLTAGES PER INSTRUCTIONS ON THE PROTECTIVE COVER OF 1A3 BEFORE ATTEMPTING THE REMOVAL OF THE PUSHBUTTON BOARD ASSEMBLY.

(3) Remove the five screws that mount the protective cover and remove the cover.

(4) Disconnect all connectors (J1-J8) to the pushbutton board assembly 1A3 and tag each connector for ease of replacement. Remove the wire connectors (E1-E7) from underneath 1A3.

(5) Remove the knobs from the INT SQ WAVE, INT FM DEV, HOR SWP PHASE and ΔF controls on the front panel.

(6) Remove the two screws that secure the pushbutton board to the front panel.

(7) Remove the remaining screws from the bindings posts that mount the pushbutton board to the chassis.

(8) Perform step f. of paragraph 4-6.

(9) Gently remove the board from the instrument.

(10) Replacement procedures are the reverse of the removal procedures.

(11) After the pushbutton board assembly 1A3 has been replaced, perform the adjustments as detailed in paragraphs 4-7c. and e.

e. Removal and Replacement of High Voltage Control Board Assembly 1A4 (fig. 4-6 and 4-6.1).

(1) Perform all steps in paragraph 4-6a.

(2) Remove the top, left side, and bottom covers (facing the instrument) of Signal Generator SG-1145/URM.

(3) Disconnect cables from connectors 1A4J1 and 1A4J2.

(4) Remove the eight screws that mount the high voltage control board 1A4 to the chassis.

(5) Replacement Procedures are the reverse of the removal procedures.

(6) After the high voltage control board 1A4 has been replaced, perform the adjustments outlined in paragraph 4-7b.

f. Removal and Replacement of High Voltage Box 1A5 (fig. 4-6 and 4.6.1).

WARNING

DISCHARGE ALL HIGH VOLTAGE AT CONNECTOR 1A5P10 (MATING WITH 1A3A1J8) BEFORE ATTEMPTING THE REMOVAL OF THE HIGH VOLTAGE BOX ASSEMBLY.

(1) Perform all steps in paragraph 4-6a.

(2) Remove the top and bottom cover of Signal Generator SG-1145/URM.

(3) Disconnect 1A5W11 and 1A5W12 (fig. 4-12) from the connection on the high voltage control board 1A4 and the pushbutton board assembly 1A3.

(4) Remove the four screws that mount the high voltage box 1A5 to the bottom of the chassis and remove.

(5) Replacement is the reverse of the removal procedures.

(6) After the high voltage has been replaced perform the adjustment procedures outlined in paragraph 4-7d.

g. Removal and Replacement of Tracking Board Assembly 1A6 and Tuning Head Assembly 1A7. The tracking board assembly 1A6 and tuning head assembly 1A7 are not to be replaced at the General Support Level. Replacement should be performed at the Depot Level.

h. Removal and Replacement of Meter Assembly 1A8 (fig. 4-6 and 4-6.1).

(1) Perform all steps in paragraph 4-6a.

(3) Remove the top and bottom covers of Signal Generator SG-1145/URM.

(3) Disconnect all wires connected to meter 1A8M1 and mark.

(4) Loosen the two screws that mount the meter assembly 1A8 to the mounting bracket.

(5) Loosen the two screws that mount the mounting bracket to the front panel and gently slide the meter assembly 1A8 out.

(6) Replacement is the reverse of removal procedures.

i. Removal and Replacement of 400-60 Hz Converter Board Assembly 1A10 (fig. 4-6).

- (1) Perform steps (1), (2) and (3) of paragraph 4-6a.
- (2) Remove the top cover of Signal Generator SG-1145/URM.
- (3) Disconnect the four clip leads of cable 1W1.
- (4) Remove the three screws that mount the 400-60 Hz converter board assembly 1A10 to the three mounting posts and remove the board.
- (5) Replacement is the reverse of the removal procedures.

j. Removal and Replacement of Klystron 1V1, Detector 1Z1, Probe Assembly 1W14 and Probe Assembly 1W15.

The klystron 1V1, detector 1Z1, probe assembly 1W14 and probe assembly 1W15 are not to be replaced at the General Support level. Replacement should be performed at the Depot level.

4-7. ADJUSTMENT PROCEDURES

See paragraph 4-8 for use of the Test Connector as an aid in making test measurements.

a. Instrument adjustment procedures are given in paragraphs 4-7b. through e. After performing any of the adjustment and calibration procedures given below, perform the minimum performance checks. Remove the top cover and left side cover of the signal generator. Connect the test connector (A713772) to 1A4TP (fig. 4-11). Connect power cord to ac source and switch POWER switch to the ON position.

WARNING

HIGH VOLTAGES ARE PRESENT AND PROPER SAFETY PRECAUTIONS MUST BE EXERCISED WHEN MAKING ANY ADJUSTMENTS.

b. -1250 Volt Adjustment.

- (1) Set the Signal Generator for CW operation (see paragraph 2-5).
- (2) Rotate BEAM CURRENT ADJ 1A5A2R5 (fig.4-6) and 4-6.1) to midpoint.
- (3) Set digital multimeter to 20 VDC range. Connect pin 4 of the test connector 1A4TP to V-Ω of the multimeter and pin 2 to COMMON.
- (4) Adjust BEAM CURRENT ADJ 1A5A2R5 for an indication of 2.50 V ± 10% on the multimeter (fig. 4-6 and 4-6.1 for location of 1A5A2R5).
- (5) Set differential voltmeter for 6000-volt dc range, connect + lead to chassis and - lead to pin 2 of connector 1A3A1J8 (fig. 4-9 and 4-9.1) 1).
- (6) Adjust the H.V. ADJ control 1A4R21 for 1250 volts ± 1 volt (fig. 4-11).
- (7) Glyptol-lock the potentiometer 1A4R21.
- (8) Disconnect the differential voltmeter.

c. -1850 Volt Adjustment.

- (1) Set the signal generator for CW operation (see paragraph 2-5).
- (2) Set differential voltmeter for 6000-volt dc range, connect + lead to chassis, and the - lead to pin 3 of connector 1A3A1J5 (fig. 4-9 and 4-9.1). I and turn ΔF control fully clockwise.
- (3) Adjust the -1850 control 1A3A1R42 for 1850 volts ± 1 volt (fig. 4-9 and 4-9. 1).
- (4) Glyptol-lock potentiometer A3A1R42.
- (5) Disconnect the differential voltmeter.
- (6) Return the ΔIF control to the center "0."

d. Beam Current Adjustment.

NOTE

The beam current is adjusted after adjusting the -1250 and -1850 volts supplies.

(1) Set the signal generator for CW operation (see paragraph 2-5).

(2) Set digital multimeter to the 20 VDC range. Connect pin 4 of the test connector 1A4TP to V-Ω of the multimeter and pin 2 to COMMON.

(3) Adjust BEAM CURRENT ADJ control 1A5A2R5 (fig. 4-6 and 4-6.1) for 2.50 V ±10% on the multimeter.

(4) Scan through the frequency band and readjust so that 2.50 V is minimum at any point.

(5) Glyptol-lock BEAM CURRENT ADJ potentiometer 1A5A2R5.

(6) Disconnect the multimeter with the signal generator on.

e. Filament Voltage Adjustment.

(1) Connect the digital voltmeter to pin 2 of connector 1A3J3 (fig. 4-9 and 4-9.1) and the COMMON lead to Pin 3 of connector 1A3J3.

(2) Adjust 6.3 Adj control 1A3R2 for + 6.3 volts (fig. 4-9 and 4-9.1).

4-8. ACCESSORY TEST CONNECTOR

The Test Connector, A713772, supplied as part of the accessory kit, is used to assemble a test cable to aid in evaluation of the performance of the signal generator and implement voltage adjustment. The cable may have a length of up to four feet without affecting performance.

The test cable is connected to 1A4TP (fig, 4-11). Under 1). normal operating conditions, voltages should be below +40 volts at test points. A failure, however, in the high voltage box 1A5 could bring this level up to several hundred volts. Caution should, therefore, be used when locating the end of the cable and when making measurements. Viewing from the top of the connector, the pin numbers will be marked as follows:



The following voltage Table 4-3 indicates normal operation, when the MODULATION SELECTOR switch is in the CW position and the voltage is at 115 vat.

After checking the voltages listed in Table 4-3, monitor the klystron beam current (pins 4 and 2). With the MODULATION SELECTOR switch in the CW position, the voltage should be between 2.5 and 2.9 volts. Push in RF OFF control and the voltages should drop to 0.4 volts. Push in IN SQ WAVE control and the voltage should increase to 1.4 to 1.6 volts.

Pin 3 controls the delay circuit, which allows the klystron filament to warm up before the application of the high voltage. During the first minute, the voltage at the pin will be approximately 800 millivolts. It will drop to 0 volt when the high voltage is activated. This is indicated when

RF signal is generated. The delay circuit may be overridden if pin 3 is shorted to ground. The RF signal will slowly build up as the filament is heated.

TABLE 4-3. VOLTAGE MEASUREMENTS DURING CW OPERATION

Test	Pin Nos.	Indication	Tol
Klystron Beam Current	4(+) to 2	2.7 vdc	±10%**
Low Voltage DC Power Supply Voltage	1(+) to 2	31 vdc	± 10%
Low Voltage DC Power Supply Current	5(+) to 1	450 mvdc	± 10%**
* * Low Voltage Bias	6(+) to 2	12 vdc	±10%

*The bias voltage must be read during the first minute after turning on the set (klystron filament warmup interval before the high voltage is applied).

**This is equivalent to 27 ma going through 1A5A1R8.

***This is equivalent to 2.25 amp going through 1A4R1.

CHAPTER 5

SCHEMATIC DIAGRAMS

5-1. GENERAL

5-2. This section contains the schematic diagrams (Figs. 5-1 through 5-6) and voltage resistance measurements (Table 5-1) that are essential aids in the maintenance of signal generator AN/URM-206. The diagrams are to be employed in conjunction with Chapter 3 to help the technician understand the operation of the units. Both the diagrams and the voltage measurements are to be used in conjunction with Chapter 4 to facilitate troubleshooting and maintenance operations.

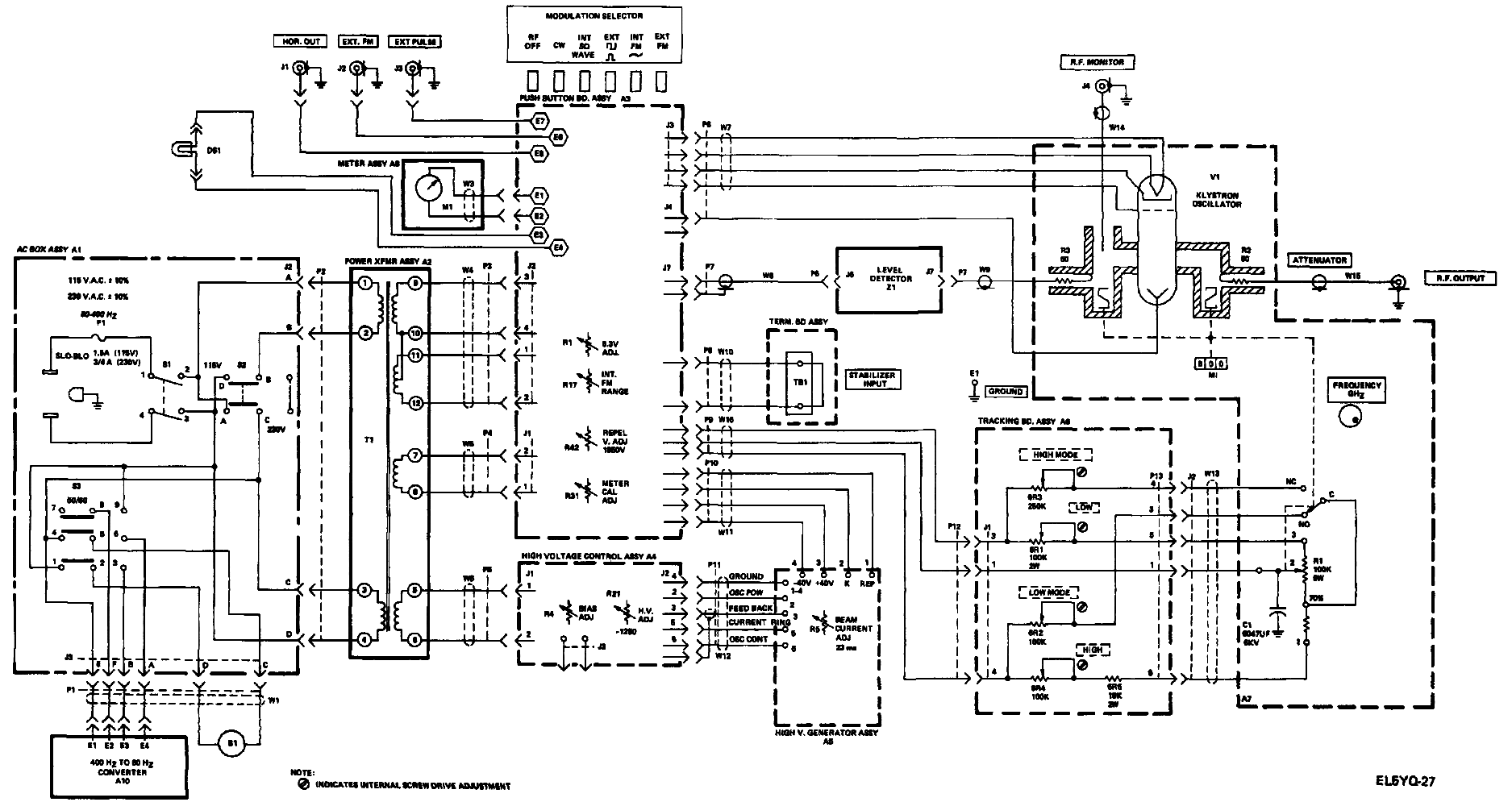

EL5YQ-27

Figure 5-1. Signal Generator SG-1145/URM, Schematic Diagram

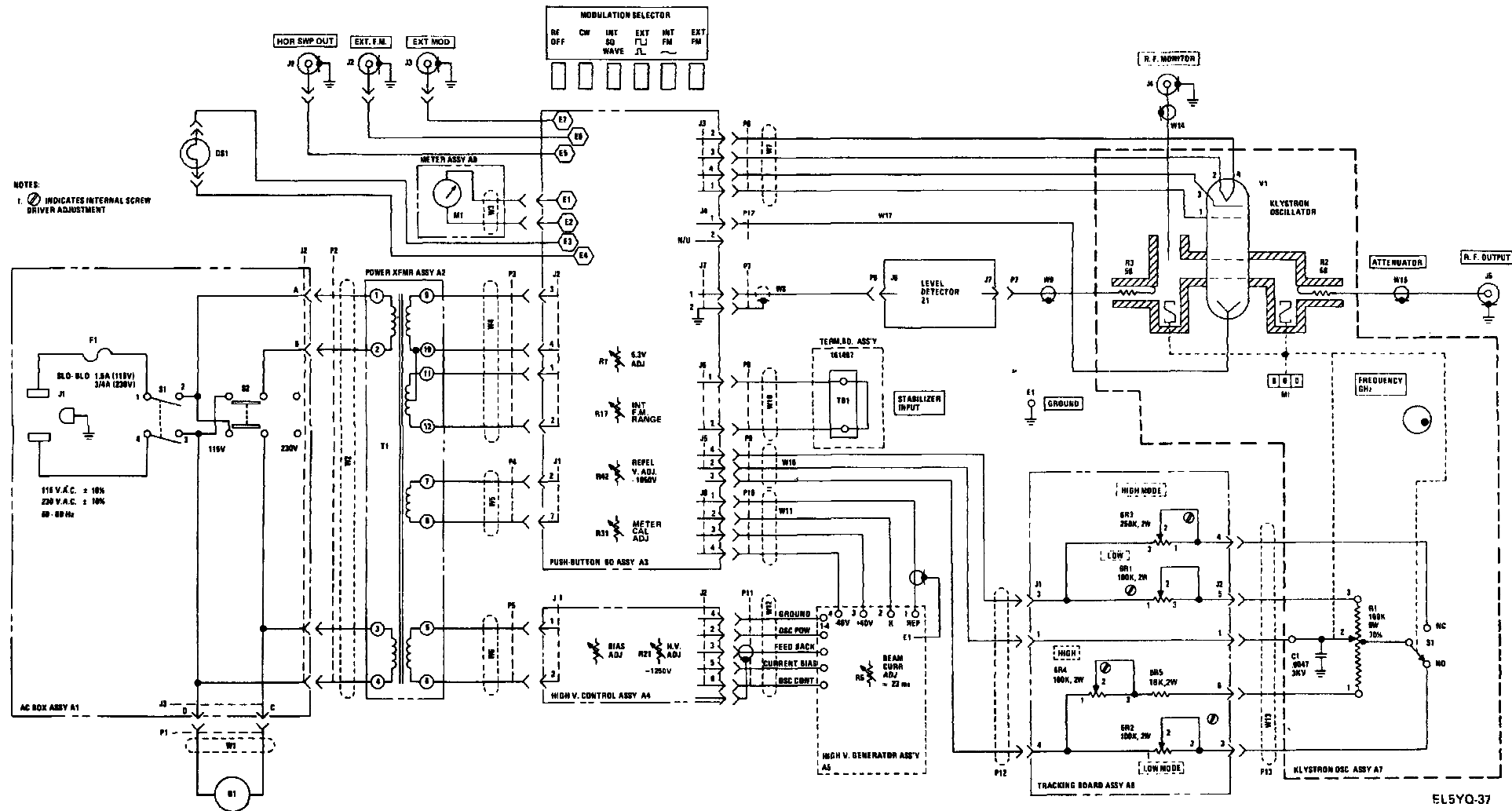
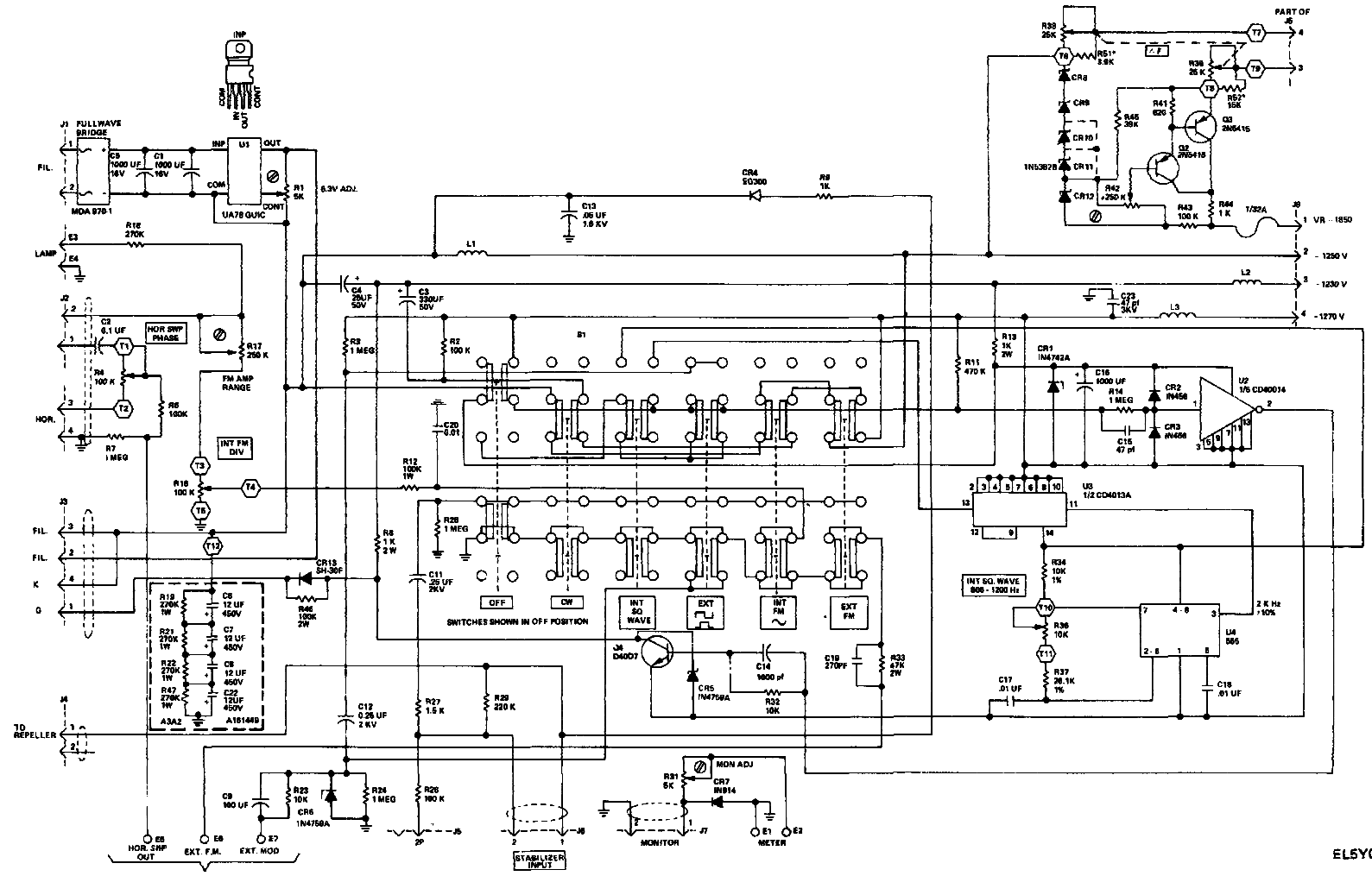
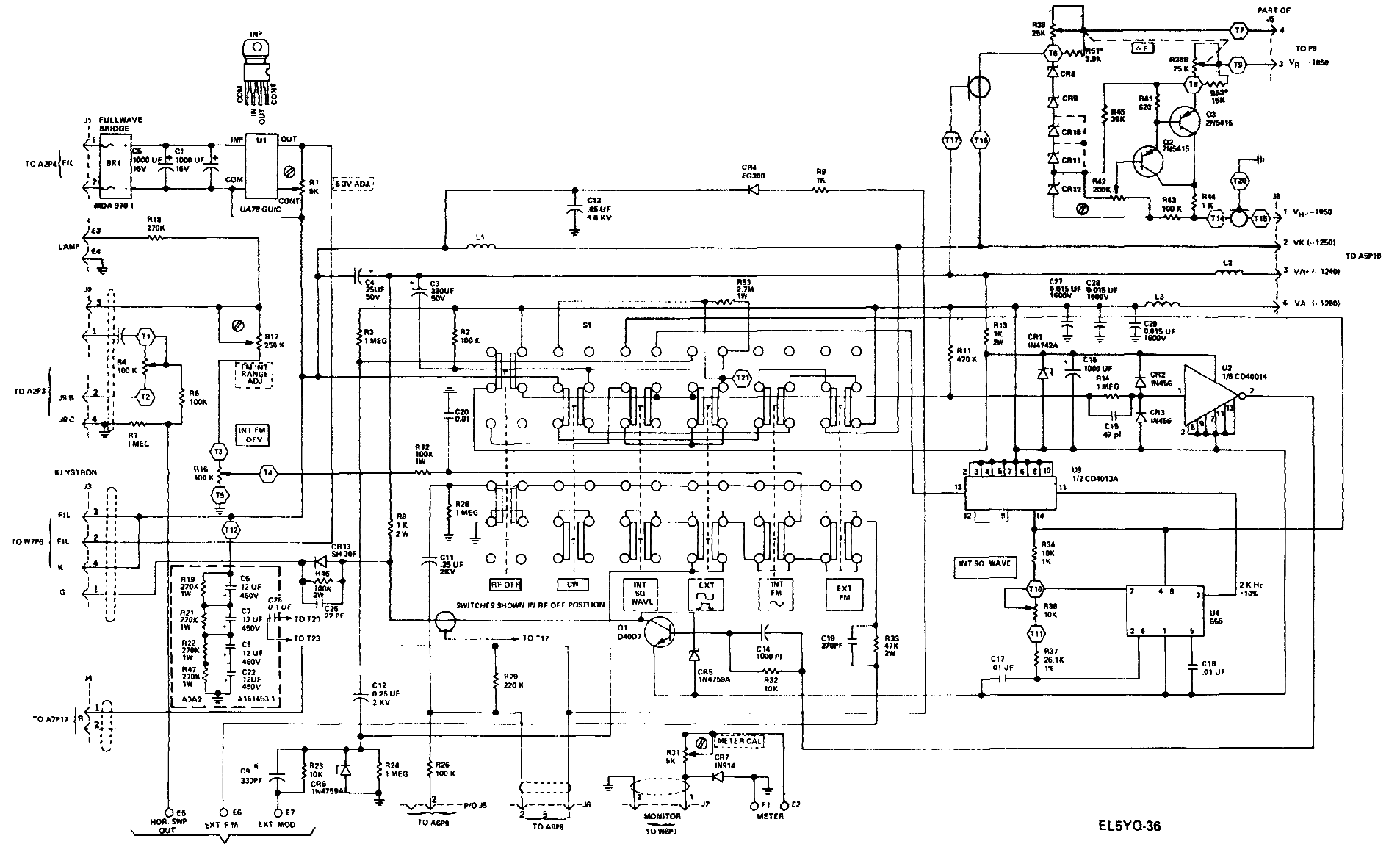

Figure 5-1.1. Signal Generator SG-1145/URM-206, Schematic Diagram (Serial No. 5-201B thru 5-511B)



EL5YQ-2B

Figure 5-2. Pushbutton Board Assembly 1A3, Schematic Diagram



EL5YQ-36

Figure 5-2.1. Pushbutton Board Assembly 1A3, Schematic Diagram (Serial No. 5-201B thru B-511B)

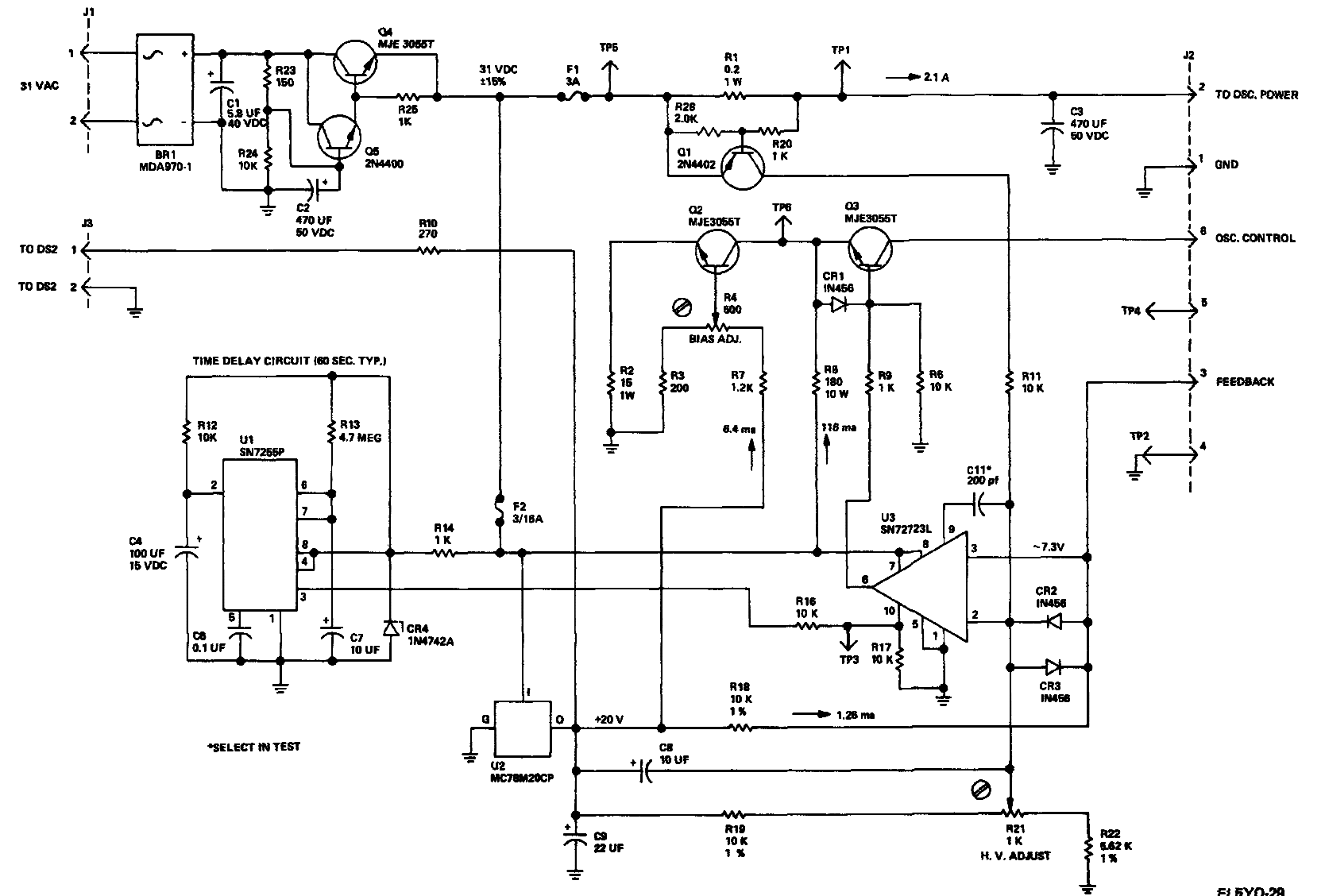

EL6YQ-29

Figure 5-3. High Voltage Control Board Assembly 1A4, Schematic Diagram

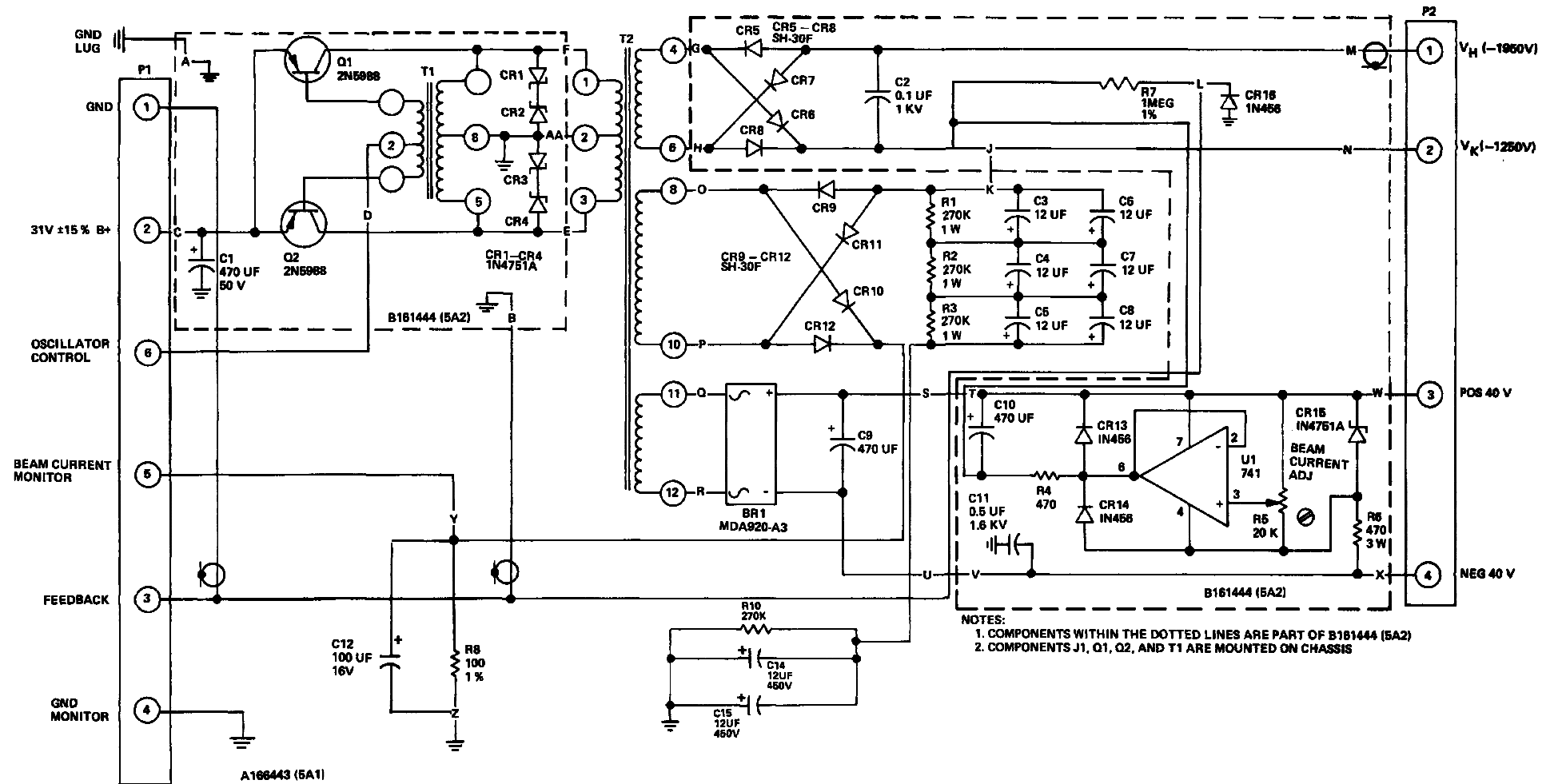

EL5YQ-30

Figure 5-4. High Voltage Box Assembly 1A5, Schematic Diagram

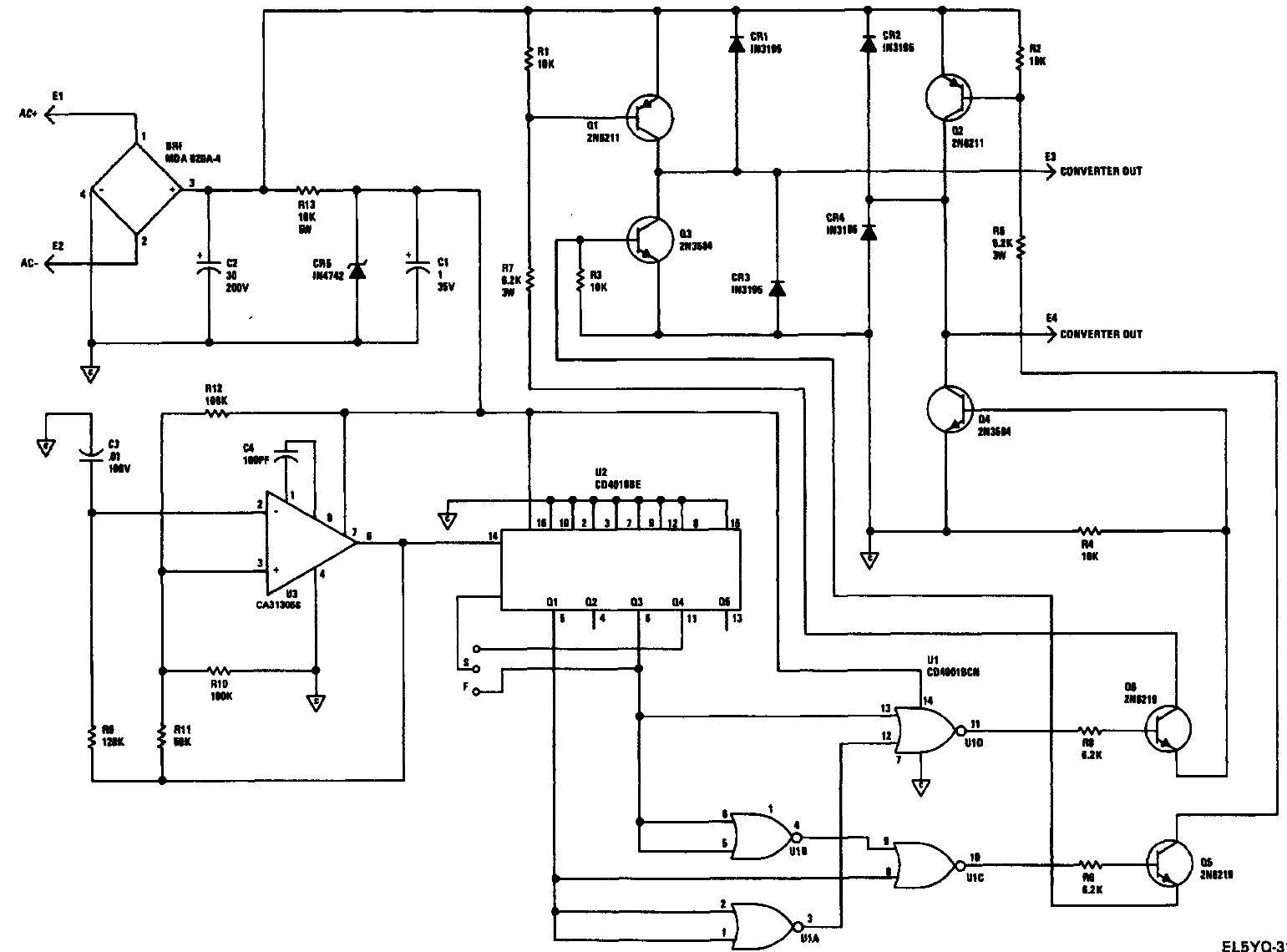

EL5YQ-31

Figure 5-5. 400 To 60 Hz Converter Board 1A10, Schematic Diagram

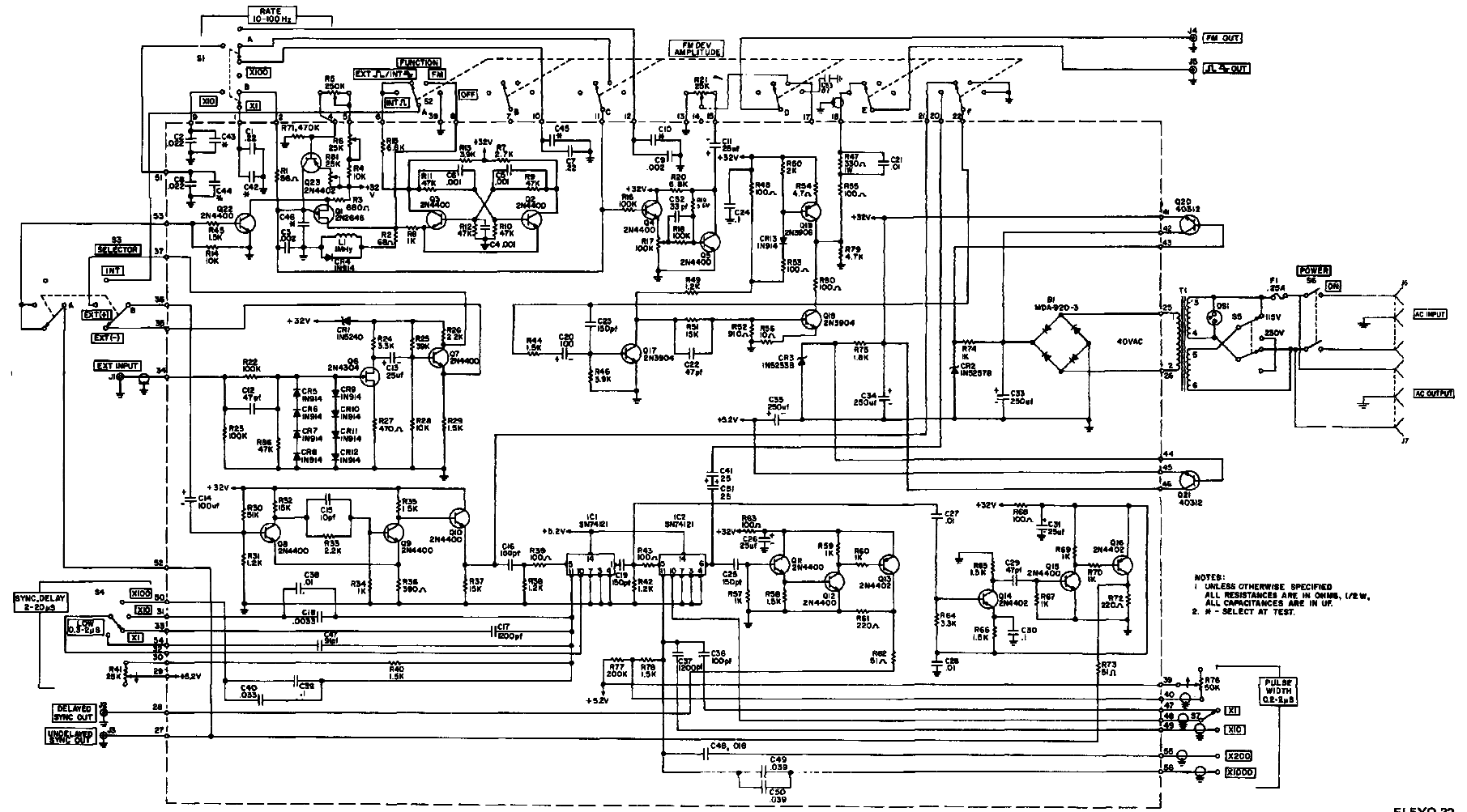

ELS5YQ-32

Figure 5-6. Modulator MD-1075/URM, Schematic Diagram

TABLE 5-1. VOLTAGE AND RESISTANCE MEASUREMENTS

		Pin Numbers															
Symbol	Part No.	1 (E)	2 (B)	3 (C)	4	5	6	7	8	9	10	11	12	13	14	Units	
PUSHBUTTON BOARD ASSEMBLY 1A3																	
1A3Q1	D40D7	0	0	+40												Ohms	
1A3U2	CD40014P	3K	3.5K	0	3.5K	0	3.5K	0	3.5K	0	3.5K	0	3.5K	0	2K	Ohms	
1A3Q3	CD4013AE	3.5K	0	0	0	0	0	0	0	0	3K	0	2.5K	3K	3K	2K	Ohms
1A3U4	SN7255P	0	3K	2K	2K	5K	3K	2.5K	2K							Ohms	
1A3J3	350430-1	+11	+6	0	0											Volts	
1A3J4	350786-1	-378	N.C.	-	-											Volts	
1A3J5	350792-1	N.C.	-209	-578	-16											Volts	
1A3J6	350786-1	-378	-378	-												Volts	
1A3J8	350792-1	-770	0	+17	-24											Volts	
HIGH VOLTAGE CONTROL BOARD ASSEMBLY 1A4																	
1A4BR1	MDA970-1	25(+)	0(-)													Ohms	
		+32.3	0													Volts	
1A4Q1	2N4402	0.3K	1.2K	15K												Ohms	
		+30.1	+29.9	+7.4												Volts	
1A4Q2	MJE3055T	15	200	45												Ohms	
		+2.0	+2.6	+10.1												Volts	
1A4Q3	MJE3055T	45	250	35												Ohms	
		+10.0	+10.6	+32.0												Volts	
1A4Q4	MJE3055T	0.3K	1.3K	1K												Ohms	
		+30.4	+31.2	+32.3												Volts	
1A4Q5	2N5190	600	450	100												Ohms	
		+31.2	+31.8	+32.3												Volts	

TABLE 5-1. VOLTAGE AND RESISTANCE MEASUREMENTS (Continued)

		Pin Numbers														
Symbol	Part No.	1 (E)	2 (B)	3 (C)	4	5	6	7	8	9	10	11	12	13	14	Units
HIGH VOLTAGE CONTROL BOARD ASSEMBLY 1A4 (cont'd)																
1A4U1	SN7255P	0	15	8	7	3.5K	2.5K	2.5K	7							Ohms
		0	+11.7	0	+11.7	+7.8	0	0	+11.7							Volts
1A4U2	MC78M20	12	1.5K	0												Ohms
		+29.8	+19.9	0												Volts
1A4U3	SN72723L	0	4K	3K	3.5K	0	3K	0.3K	0.3K	3.5K	7K					Ohms
		0	+7.4	+7.4	+7.4	0	+11.6	+29.8	+29.8	+12.6	0					Volts
HIGH VOLTAGE BOX ASSEMBLY 1A5																
1A5Q1	2N5988	15	4	0												Ohms
		+32.13	+32.6	0												Volts
1A5Q2	2N5988	15	4	0												Ohms
		+32.0	+32.6	0												Volts
1A5A2U2	SN7241L	2K	3.5K	6K	0.4K	2K	3.5K	2.5K	00							Ohms
Do not attempt voltage measurements as high voltages are present.																
Note:	1. Measurements taken with Fluke Model 8000A Differential Voltmeter and Triplet Model 630A Voltmeter 2. - COMMON lead attached to chassis GND 3. MODULATION SELECTOR switch in CW position															

APPENDIX A REFERENCES

A-1. SCOPE.

This appendix lists all forms, field manuals, technical manuals, and miscellaneous publication references in this manual.

A-2. FORMS.

Product Quality Deficiency Report	SF 368
Recommended Changes to Equipment Technical Manuals	DA Form 2028-2
Recommended Changes to Publications and Blank Forms	DA Form 2028
Report of Discrepancy (ROD)	SF 364
Transportation Discrepancy Report (TDR)	SF 361

A-3. TECHNICAL MANUALS.

Procedures for Destruction of Electronics Materiel to Prevent Enemy Use (Electronics Command)	TM 750-244-2
Operator's, Organizational, Direct Support and General Support Maintenance Manual Including Repair Parts and Special Tools List for Counter, Electronic, Digital Readout AN/USM-459 (Hewlett-Packard Model 5328A-E42) (NSN 6625-01-061-8928)	TM 11-6625-2941-14&P
Organizational, Direct Support and General Support Maintenance Repair Parts and Special Tools List (Including Depot Maintenance Repair Parts and Special Tools) For Signal Generator AN/URM-206 (NSN 6625-01-061-8928)	TM 11-6625-2948-24P

A-4. MISCELLANEOUS PUBLICATIONS.

Consolidated Index of Army Publications and Blank Forms	DA PAM 25-30
Interactive Electronic Technical Manual (IETM) for Calibration and Repair Requirements for the Maintenance of Army Materiel.....	TB 43-180
Field Instructions for Painting and Preserving Communications-Electronics Equipment	TB 43-0118
The Army Maintenance Management System (TAMMS) Users Manual	DA PAM 750-8

APPENDIX B

COMPONENTS OF END ITEM LIST

Section I. INTRODUCTION

B-1. Scope

This appendix lists integral components of and basic issue items for the AN/URM-206 to help you inventory items required for safe and efficient operation.

B-2. General

This Components of End Item List is divided into the following sections:

a. Section II. Integral Components of the End Item. These items, when assembled, comprise the AN/URM-206 and must accompany it whenever it is transferred or turned in. The illustrations will help you identify these items.

b. Section III. Basic Issue Items. These are the minimum essential items required to place the AN/URM-206 in operation, to operate it, and to perform emergency repairs. Although shipped separately packed they must accompany the AN/URM-206 during operation and whenever it is transferred between accountable officers. The illustrations will assist you with hard-to-identify items. This manual is your authority to requisition replacement BII, based on TOE/MTOE authorization of the end item.

B-3. Explanation of Columns

a. Illustration. This column is divided as follows:

(1) *Figure number.* Indicates the figure number of the illustration on which the item is shown.

(2) *Item number.* The number used to identify item called out in the illustration.

b. National Stock Number. Indicates the National stock number assigned to the item and which will be used for requisitioning.

c. Description. Indicates the Federal item name and, if required, a minimum description to identify the item. The part number (when applicable) indicates the primary number used by the manufacturer, which controls the design and characteristics of the item by means of its engineering drawings, specifications, standards, and inspection requirements to identify an item or range of items. Following the part number, the Federal Supply Code for Manufacturers (FSCM) (as applicable) is shown in parentheses.

d. Location. The physical location of each item listed is given in this column. The lists are designed to inventory all items in one area of the major item before moving on to an adjacent area.

e. Usable on Code. Not applicable.

f. Quantity Required (Qty Reqd). This column lists the quantity of each item required for a complete major item.

g. Quantity. This column is left blank for use during an inventory. Under the Rcvd column, list the quantity you actually received on your major item. The Date columns are for your use when you inventory the major item.

1	2	3	4	5	6	7
ILLUSTRATION	NATIONAL	DESCRIPTION	LOCATION	USABLE	QTY	QUANTITY
A	B	STOCK		ON	REQD	RCVD
FIG	ITEM	NUMBER		CODE		DATE
NO.	NO.	PART NO.	(FSCM)			
		SIGNAL GENERATOR 1108E-Y	(82199)		1	
		MODULATOR 1020A-Y	(82199)		1	
		SUPPORT PLATE A153211	(82199)		4	
		TEST PLUG A161543	(82199)		1	
		CABLE ASSEMBLY, POWER B160833	(82199)		1	
		CABLE ASSEMBLY, POWER B160826	(82199)		1	
		CABLE ASSEMBLY, RF BP12551	(82199)		1	
		CABLE ASSEMBLY, VIDEO BP12553	(82199)		1	
		CABLE ASSEMBLY, VIDEO C147363	(82199)		2	
		BRACKET, RACK MOUNT A165931-1	(82199)		1	
		BRACKET, RACK MOUNT A165931-2	(82199)		1	
		WRENCH KIT A25109	(82199)		1	
		FUSE, CARTRIDGE, 1/8 AMP 312.031	(75915)		1	
		FUSE, CARTRIDGE, 1/4 AMP 312.25	(75915)		1	

APPENDIX C
ADDITIONAL AUTHORIZATION LIST

NOT APPLICABLE

APPENDIX D

MAINTENANCE ALLOCATION

Section I. INTRODUCTION

D-1. General

This appendix provides a summary of the maintenance operations for AN/URM-206. It authorizes categories of maintenance for specific maintenance functions on repairable items and components and the tools and equipment required to perform each function. This appendix may be used as an aid in planning maintenance operations.

D-2. Maintenance Function

Maintenance functions will be limited to and defined as follows:

a. Inspect. To determine the serviceability of an item by comparing its physical, mechanical, and/or electrical characteristics with established standards through examination.

b. Test. To verify serviceability and to detect incipient failure by measuring the mechanical or electrical characteristics of an item and comparing those characteristics with prescribed standards.

c. Service. Operations required periodically to keep an item in proper operating condition; i.e., to clean (decontaminate), to preserve, to drain, to paint, or to replenish fuel, lubricants, hydraulic fluids, or compressed air supplies.

d. Adjust. To maintain, within prescribed limits, by bringing into proper or exact position, or by setting the operating characteristics to the specified parameters.

e. Align. To adjust specified variable elements of an item to bring about optimum or desired performance.

f. Calibrate. To determine and cause corrections to be made or to be adjusted on instruments or test measuring and diagnostic equipments used in precision measurement. Consists of comparisons of two instruments, one of which is a certified standard of known accuracy, to detect and adjust any discrepancy in the accuracy of the instrument being compared.

g. Install. The act of emplacing, seating, or fixing into position an item, part, module (component or assembly) in a manner to allow the proper functioning of the equipment or system.

h. Replace. The act of substituting a serviceable like type part, subassembly, or module (component or assembly) for an unserviceable counterpart.

i. Repair. The application of maintenance services (inspect, test, service, adjust, calibrate, replace) or other maintenance actions (welding, grinding, riveting, straightening, facing, remachining, or resurfacing) to restore serviceability to an item by correcting specific damage, fault, malfunction, or failure in a part, sub-assembly, module (component or assembly), end item, or system.

j. Overhaul. That maintenance effort (service/action) necessary to restore an item to a completely serviceable/operational condition as prescribed by maintenance standards (i.e., DMWR) in appropriate technical publications. Overhaul is normally the highest degree of maintenance performed by the Army. Overhaul does not normally return an item to like new condition.

k. Rebuild. Consists of those services/actions necessary for the restoration of unserviceable equipment to a like new condition in accordance with original manufacturing standards. Rebuild is the highest degree of materiel maintenance applied to Army equipment. The rebuild operation includes the act of returning to zero those age measurements (hours, miles, etc.) considered in classifying Army equipments/components,

D-3. Column Entries

a. Column 1, Group Number. Column 1 lists group numbers, the purpose of which is to identify components, assemblies, subassemblies, and modules with the next higher assembly.

b. Column 2, Component/Assembly. Column 2 contains the noun names of components, assemblies, subassemblies, and modules for which maintenance is authorized.

c. Column 3, Maintenance Functions. Column 3 lists the functions to be performed on the item listed in column 2. When items are listed without maintenance functions, it is solely for purpose of having the group numbers in the MAC and RPSTL coincide.

d. Column 4, Maintenance Category. Column 4 specifies, by the listing of a "work time" figure in the appropriate subcolumn(s), the lowest level of maintenance authorized to perform the function listed in column 3. This figure represents the active time re-

quired to perform that maintenance function at the indicated category of maintenance. If the number or complexity of the tasks within the listed maintenance function vary at different maintenance categories, appropriate "work time" figures will be shown for each category. The number of task-hours specified by the "work time" figure represents the average time required to restore an item (assembly, subassembly, component, module, end item or system) to a serviceable condition under typical field operating conditions. This time includes preparation time, troubleshooting time, and quality assurance/quality control time in addition to the time required to perform the specific tasks identified for the maintenance functions authorized in the maintenance allocation chart. Subcolumns of column 4 are as follows:

- C — Operator/Crew
- O — Organizational
- F — Direct Support
- H — General Support
- D — D e p o t

e. Column 5, Tools and Equipment. Column 5 specifies by code, those common tool sets (not individual tools) and special tools, test, and support equipment required to perform the designated function.

f. Column 6, Remarks. Not applicable.

D-4. Tool and Test Equipment Requirements (Sec III)

a. Tool or Test Equipment Reference Code. The numbers in this column coincide with the numbers used in the tools and equipment column of the MAC. The numbers indicate the applicable tool or test equipment for the maintenance functions.

b. Maintenance Category. The codes in this column indicate the maintenance category allocated the tool or test equipment.

c. Nomenclature. This column lists the noun name and nomenclature of the tools and test equipment required to perform the maintenance functions.

d. National/NATO Stock Number. This column lists the National/NATO stock number of the specific tool or test equipment.

e. Tool Number. This column lists the manufacturer's part number of the tool followed by the Federal Supply Code for manufacturers (5-digit) in parentheses.

D-5. Remarks (See IV)

Not applicable.

**SECTION II. MAINTENANCE ALLOCATION CHART
FOR
GENERATOR, SIGNAL AN/URM-206**

(1) GROUP NUMBER	(2) COMPONENT/ASSEMBLY	(3) MAINTENANCE FUNCTION	(3) MAINTENANCE CATEGORY					(5) TOOLS AND EQUIPMENT	(6) REMARKS
			C	O	F	H	D		
00	SIGNAL GENERATOR AN/URM-206	INSPECT TEST TEST SERVICE REPAIR OVERHAUL		0.3		1.5 0.5	2.0 2.0 3.0	14 1 thru 11 1 thru 13 1 thru 11 1 thru 13 1 thru 13	
01	SIGNAL GENERATOR SG-1145	INSPECT TEST TEST SERVICE REPLACE REPAIR OVERHAUL		0.2		1.5 0.5 0.5	2.0 2.0 3.0	14 1 thru 11 1 thru 13 1 thru 11 1 thru 11 1 thru 13 1 thru 13	
0101	PUSHBUTTON BOARD ASSEMBLY 0161469	TEST REPLACE REPAIR				0.3 0.5	0.8	1 thru 11 1 thru 11 1 thru 11	
0102	HIGH VOLTAGE CONTROL BOARD C161321	TEST REPLACE REPAIR				0.3 0.5	0.8	1 thru 11 1 thru 11 1 thru 13	
0103	HIGH VOLTAGE BOX D161309	TEST REPLACE REPAIR				0.5 0.5	1.0	1 thru 11 1 thru 11 1 thru 13	
0104	KLYSTRON A1600134	REPLACE					2.0	1 thru 13	
0105	DETECTOR A160359	TEST REPLACE				0.5	1.0	1 thru 11 1 thru 11	
0106	400-60 HZ CONVERTER BD ASSY C161519	TEST REPLACE				0.3	0.3	1 thru 11 1 thru 11	
0107	ATTENUATOR PROBE CABLE ASSEMBLY C160850	INSPECT REPAIR REPLACE		0.1		0.5 2.0		14 2 thru 7 2	
0108	RF MONITOR PROBE CABLE ASSEMBLY A149252	INSPECT REPAIR REPLACE		0.1		0.5 2.0		14 2 thru 7 2	
02	MODULATOR MD-1075	INSPECT TEST SERVICE REPLACE REPAIR OVERHAUL		0.1		0.5 0.5 0.3	0.1 2.0	14 1 thru 11 1 thru 11 1 thru 11 1 thru 11 1 thru 11	

**SECTION III. TOOLS AND TEST EQUIPMENT REQUIREMENTS
FOR
GENERATOR, SIGNAL AN/URM-206**

(1) TOOLS OR TEST EQUIPMENT REF CODE	(2) MAINTENANCE CATEGORY	(3) NOMENCLATURE	(4) NATIONAL STOCK NUMBER	(5) TOOL NUMBER
1	H	COUNTER, ELECTRONIC, DIGITAL READOUT, AN/USM-459	6625-01-061-8928	
2	H	POWER METER HP 435 A	6625-00-499-9167	
3	H	POWER SENSOR HP 8481A	6625-00-354-9762	
4	H	OSCILLOSCOPE AN/USM- 281C	6625-00-106-9632	
5	H	ATTENUATOR PAD HF A50ATT3DB		
6	H	DECTOR, HP-423B		
7	H	MULTIMETER, TRIPLETT 630A	6625-00-553-0251	
8	H	WAVEMETER ME-495	6625-00-930-9687	
9	H	SPECTRUM ANALYZER IP 1216 (HP 141T)	6625-00-424-4370	
10	H	SPECT ANAL PLUG-IN PL 1400/U (HP 8555 A)	6625-00-422-4314	
11	H	PULSE GENERATOR AN/UPM-15	6625-00-643-5969	
12	D	DIFFERENTIAL VOLTMETER FLUKE 801		
13	D	VOLTAGE BOX (10:1) FLUKE 605B		
14	O	COMMON TOOLS NECESSARY TO THE PERFORMANCE OF THIS MAINTENANCE FUNCTION ARE AVAILABLE TO MAINTENANCE PERSONNEL, FOR THE MAINTENANCE CATEGORY LISTED.		

APPENDIX E
EXPENDABLE SUPPLIES AND MATERIALS LIST

NOT APPLICABLE

APPENDIX F
REPAIR PARTS AND SPECIAL TOOLS LIST

For Repair Parts and Special Tools for the Generator, Signal AN/URM-206, refer to TM 11-6625-2948-24P.

By Order of the Secretary of the Army:

E. C. MEYER
General, United States Army
Chief of Staff

Official:

J. C. PENNINGTON
Major General, United States Army
The Adjutant General

DISTRIBUTION:

Active Army:

HISA (Ft Monmouth) (21)
 USAINSCOM (2)
 COE (1)
 TSG (1)
 USAARENBD (1)
 DARCOM (1)
 TRADOC (2)
 OS Maj Cmd (4)
 TECOM (2)
 USACC (4)
 MDW (1)
 Armies (2)
 Corps (2)
 Svc Colleges (1)
 USASIGS (5)
 USAADS (2)
 USAFAS (2)
 USAARMS (2)
 USAIS (2)
 USAES (2)

NG: None.

USAR: None.

For explanation of abbreviations used, see AR 310-50.

USAICS (3)
 MAAG (1)
 USARMIS (1)
 USAERDAW (1)
 USAERDAA (1)
 Ft Grodon (10)
 Ft Carsom (5)
 Army Depot (1) except:
 LBAD (14)
 SAAD (30)
 TOAD (14)
 SHAD (3)
 Ft Gillem (10)
 USA Dep (1)
 Sig Sec USA Dep (1)
 Ft Richardson (CERCOM Ofc) (2)
 Units org under fol TOE:
 29-207 (2)
 29-610 (2)

These are the instructions for sending an electronic 2028

The following format must be used if submitting an electronic 2028. The subject line must be exactly the same and all fields must be included; however only the following fields are mandatory: 1, 3, 4, 5, 6, 7, 8, 9, 10, 13, 15, 16, 17, and 27.

From: "Whomever" <whomever@wherever.army.mil>

To: 2028@redstone.army.mil

Subject: DA Form 2028

1. **From:** Joe Smith
2. **Unit:** home
3. **Address:** 4300 Park
4. **City:** Hometown
5. **St:** MO
6. **Zip:** 77777
7. **Date Sent:** 19-OCT-93
8. **Pub no:** 55-2840-229-23
9. **Pub Title:** TM
10. **Publication Date:** 04-JUL-85
11. **Change Number:** 7
12. **Submitter Rank:** MSG
13. **Submitter FName:** Joe
14. **Submitter MName:** T
15. **Submitter LName:** Smith
16. **Submitter Phone:** 123-123-1234
17. **Problem:** 1
18. **Page:** 2
19. **Paragraph:** 3
20. **Line:** 4
21. **NSN:** 5
22. **Reference:** 6
23. **Figure:** 7
24. **Table:** 8
25. **Item:** 9
26. **Total:** 123
27. **Text:**

This is the text for the problem below line 27.

RECOMMENDED CHANGES TO PUBLICATIONS AND BLANK FORMS <small>For use of this form, see AR 25-30; the proponent agency is ODISC4.</small>	Use Part II (reverse) for Repair Parts and Special Tool Lists (RPSTL) and Supply Catalogs/Supply Manuals (SC/SM)	DATE 8/30/02
--	--	----------------------------

TO: (Forward to proponent of publication or form)(Include ZIP Code) Commander, U.S. Army Aviation and Missile Command ATTN: AMSAM-MMC-MA-NP Redstone Arsenal, 35898	FROM: (Activity and location)(Include ZIP Code) MSG, Jane Q. Doe 1234 Any Street Nowhere Town, AL 34565
--	--

PART 1 - ALL PUBLICATIONS (EXCEPT RPSTL AND SC/SM) AND BLANK FORMS

PUBLICATION/FORM NUMBER TM 9-1005-433-24	DATE 16 Sep 2002	TITLE Organizational, Direct Support, And General Support Maintenance Manual for Machine Gun, .50 Caliber M3P and M3P Machine Gun Electrical Test Set Used On Avenger Air Defense Weapon System
--	----------------------------	---

ITEM NO.	PAGE NO.	PARA-GRAPH	LINE NO. *	FIGURE NO.	TABLE NO.	RECOMMENDED CHANGES AND REASON
1	WP0005 PG 3		2			Test or Corrective Action column should identify a different WP number. <div style="position: absolute; top: 50%; left: 50%; transform: translate(-50%, -50%) rotate(-45deg); font-size: 100px; opacity: 0.5; pointer-events: none;"> EXAMPLE </div>

** Reference to line numbers within the paragraph or subparagraph.*

TYPED NAME, GRADE OR TITLE MSG, Jane Q. Doe, SFC	TELEPHONE EXCHANGE/ AUTOVON, PLUS EXTENSION 788-1234	SIGNATURE
--	---	-----------

TO: (Forward direct to addressee listed in publication) Commander, U.S. Army Aviation and Missile Command ATTN: AMSAM-MMC-MA-NP Redstone Arsenal, 35898	FROM: (Activity and location) (Include ZIP Code) MSG, Jane Q. Doe 1234 Any Street Nowhere Town, AL 34565	DATE 8/30/02
---	--	------------------------

PART II - REPAIR PARTS AND SPECIAL TOOL LISTS AND SUPPLY CATALOGS/SUPPLY MANUALS

PUBLICATION NUMBER			DATE	TITLE				
PAGE NO.	COLM NO.	LINE NO.	NATIONAL STOCK NUMBER	REFERENCE NO.	FIGURE NO.	ITEM NO.	TOTAL NO. OF MAJOR ITEMS SUPPORTED	RECOMMENDED ACTION

PART III - REMARKS (Any general remarks, corrections, or suggestions for improvement of publications and blank forms. Additional blank sheets may be used if more space is needed.)

EXAMPLE

TYPED NAME, GRADE OR TITLE MSG, Jane Q. Doe, SFC	TELEPHONE EXCHANGE/AUTOVON, PLUS EXTENSION 788-1234	SIGNATURE
---	--	-----------

RECOMMENDED CHANGES TO PUBLICATIONS AND BLANK FORMS For use of this form, see AR 25-30; the proponent agency is ODISC4.	Use Part II (reverse) for Repair Parts and Special Tool Lists (RPSTL) and Supply Catalogs/Supply Manuals (SC/SM)	DATE
---	--	------

TO: (Forward to proponent of publication or form)(Include ZIP Code)	FROM: (Activity and location)(Include ZIP Code)
---	---

PART 1 - ALL PUBLICATIONS (EXCEPT RPSTL AND SC/SM) AND BLANK FORMS

PUBLICATION/FORM NUMBER	DATE	TITLE
-------------------------	------	-------

ITEM NO.	PAGE NO.	PARA-GRAPH	LINE NO. *	FIGURE NO.	TABLE NO.	RECOMMENDED CHANGES AND REASON

** Reference to line numbers within the paragraph or subparagraph.*

TYPED NAME, GRADE OR TITLE	TELEPHONE EXCHANGE/ AUTOVON, PLUS EXTENSION	SIGNATURE
----------------------------	--	-----------

TO: (Forward direct to addressee listed in publication)	FROM: (Activity and location) (Include ZIP Code)	DATE
--	---	-------------

PART II - REPAIR PARTS AND SPECIAL TOOL LISTS AND SUPPLY CATALOGS/SUPPLY MANUALS

PUBLICATION NUMBER	DATE	TITLE
--------------------	------	-------

PAGE NO.	COLM NO.	LINE NO.	NATIONAL STOCK NUMBER	REFERENCE NO.	FIGURE NO.	ITEM NO.	TOTAL NO. OF MAJOR ITEMS SUPPORTED	RECOMMENDED ACTION

PART III - REMARKS (Any general remarks or recommendations, or suggestions for improvement of publications and blank forms. Additional blank sheets may be used if more space is needed.)

TYPED NAME, GRADE OR TITLE	TELEPHONE EXCHANGE/AUTOVON, PLUS EXTENSION	SIGNATURE
----------------------------	--	-----------

RECOMMENDED CHANGES TO PUBLICATIONS AND BLANK FORMS For use of this form, see AR 25-30; the proponent agency is ODISC4.	Use Part II (reverse) for Repair Parts and Special Tool Lists (RPSTL) and Supply Catalogs/Supply Manuals (SC/SM)	DATE
---	--	------

TO: (Forward to proponent of publication or form)(Include ZIP Code)	FROM: (Activity and location)(Include ZIP Code)
---	---

PART 1 - ALL PUBLICATIONS (EXCEPT RPSTL AND SC/SM) AND BLANK FORMS

PUBLICATION/FORM NUMBER	DATE	TITLE
-------------------------	------	-------

ITEM NO.	PAGE NO.	PARA-GRAPH	LINE NO. *	FIGURE NO.	TABLE NO.	RECOMMENDED CHANGES AND REASON

** Reference to line numbers within the paragraph or subparagraph.*

TYPED NAME, GRADE OR TITLE	TELEPHONE EXCHANGE/ AUTOVON, PLUS EXTENSION	SIGNATURE
----------------------------	--	-----------

TO: (Forward direct to addressee listed in publication)	FROM: (Activity and location) (Include ZIP Code)	DATE
--	---	-------------

PART II - REPAIR PARTS AND SPECIAL TOOL LISTS AND SUPPLY CATALOGS/SUPPLY MANUALS

PUBLICATION NUMBER	DATE	TITLE
---------------------------	-------------	--------------

PAGE NO.	COLM NO.	LINE NO.	NATIONAL STOCK NUMBER	REFERENCE NO.	FIGURE NO.	ITEM NO.	TOTAL NO. OF MAJOR ITEMS SUPPORTED	RECOMMENDED ACTION

PART III - REMARKS (Any general remarks or recommendations, or suggestions for improvement of publications and blank forms. Additional blank sheets may be used if more space is needed.)

TYPED NAME, GRADE OR TITLE	TELEPHONE EXCHANGE/AUTOVON, PLUS EXTENSION	SIGNATURE
----------------------------	--	-----------

RECOMMENDED CHANGES TO PUBLICATIONS AND BLANK FORMS For use of this form, see AR 25-30; the proponent agency is ODISC4.	Use Part II (reverse) for Repair Parts and Special Tool Lists (RPSTL) and Supply Catalogs/Supply Manuals (SC/SM)	DATE
---	--	------

TO: (Forward to proponent of publication or form)(Include ZIP Code)	FROM: (Activity and location)(Include ZIP Code)
---	---

PART 1 - ALL PUBLICATIONS (EXCEPT RPSTL AND SC/SM) AND BLANK FORMS

PUBLICATION/FORM NUMBER	DATE	TITLE
-------------------------	------	-------

ITEM NO.	PAGE NO.	PARA-GRAPH	LINE NO. *	FIGURE NO.	TABLE NO.	RECOMMENDED CHANGES AND REASON

** Reference to line numbers within the paragraph or subparagraph.*

TYPED NAME, GRADE OR TITLE	TELEPHONE EXCHANGE/ AUTOVON, PLUS EXTENSION	SIGNATURE
----------------------------	--	-----------

TO: (Forward direct to addressee listed in publication)	FROM: (Activity and location) (Include ZIP Code)	DATE
--	---	-------------

PART II - REPAIR PARTS AND SPECIAL TOOL LISTS AND SUPPLY CATALOGS/SUPPLY MANUALS

PUBLICATION NUMBER	DATE	TITLE
---------------------------	-------------	--------------

PAGE NO.	COLM NO.	LINE NO.	NATIONAL STOCK NUMBER	REFERENCE NO.	FIGURE NO.	ITEM NO.	TOTAL NO. OF MAJOR ITEMS SUPPORTED	RECOMMENDED ACTION

PART III - REMARKS (Any general remarks or recommendations, or suggestions for improvement of publications and blank forms. Additional blank sheets may be used if more space is needed.)

TYPED NAME, GRADE OR TITLE	TELEPHONE EXCHANGE/AUTOVON, PLUS EXTENSION	SIGNATURE
----------------------------	--	-----------

THE METRIC SYSTEM AND EQUIVALENTS

WEIGHT MEASURE

1 Centimeter = 10 Millimeters = 0.01 Meters = 0.3937 Inches
 1 Meter = 100 Centimeters = 1000 Millimeters = 39.37 Inches
 1 Kilometer = 1000 Meters = 0.621 Miles

WEIGHTS

1 Gram = 0.001 Kilograms = 1000 Milligrams = 0.035 Ounces
 1 Kilogram = 1000 Grams = 2.2 lb.
 1 Metric Ton = 1000 Kilograms = 1 Megagram = 1.1 Short Tons

LIQUID MEASURE

1 Milliliter = 0.001 Liters = 0.0338 Fluid Ounces
 1 Liter = 1000 Milliliters = 33.82 Fluid Ounces

SQUARE MEASURE

1 Sq. Centimeter = 100 Sq. Millimeters = 0.155 Sq. Inches
 1 Sq. Meter = 10,000 Sq. Centimeters = 10.76 Sq. Feet
 1 Sq. Kilometer = 1,000,000 Sq. Meters = 0.386 Sq. Miles

CUBIC MEASURE

1 Cu. Centimeter = 1000 Cu. Millimeters = 0.06 Cu. Inches
 1 Cu. Meter = 1,000,000 Cu. Centimeters = 35.31 Cu. Feet

TEMPERATURE

$5/9(^{\circ}\text{F} - 32) = ^{\circ}\text{C}$
 212° Fahrenheit is equivalent to 100° Celsius
 90° Fahrenheit is equivalent to 32.2° Celsius
 32° Fahrenheit is equivalent to 0° Celsius
 $9/5^{\circ}\text{C} + 32 = ^{\circ}\text{F}$

APPROXIMATE CONVERSION FACTORS

TO CHANGE	TO	MULTIPLY BY
Inches	Centimeters	2.540
Feet	Meters	0.305
Yards	Meters	0.914
Miles	Kilometers	1.609
Square Inches	Square Centimeters	6.451
Square Feet	Square Meters	0.093
Square Yards	Square Meters	0.836
Square Miles	Square Kilometers	2.590
Acres	Square Hectometers	0.405
Cubic Feet	Cubic Meters	0.028
Cubic Yards	Cubic Meters	0.765
Fluid Ounces	Milliliters	29.573
its	Liters	0.473
arts	Liters	0.946
allons	Liters	3.785
Ounces	Grams	28.349
Pounds	Kilograms	0.454
Short Tons	Metric Tons	0.907
Pound-Feet	Newton-Meters	1.356
Pounds per Square Inch	Kilopascals	6.895
Miles per Gallon	Kilometers per Liter	0.425
Miles per Hour	Kilometers per Hour	1.609

TO CHANGE	TO	MULTIPLY BY
Centimeters	Inches	0.394
Meters	Feet	3.280
Meters	Yards	1.094
Kilometers	Miles	0.621
Square Centimeters	Square Inches	0.155
Square Meters	Square Feet	10.764
Square Meters	Square Yards	1.196
Square Kilometers	Square Miles	0.386
Square Hectometers	Acres	2.471
Cubic Meters	Cubic Feet	35.315
Cubic Meters	Cubic Yards	1.308
Milliliters	Fluid Ounces	0.034
Liters	Pints	2.113
Liters	Quarts	1.057
ers	Gallons	0.264
ms	Ounces	0.035
ograms	Pounds	2.205
Metric Tons	Short Tons	1.102
Newton-Meters	Pounds-Feet	0.738
Kilopascals	Pounds per Square Inch	0.145
ometers per Liter	Miles per Gallon	2.354
ometers per Hour	Miles per Hour	0.621

